

Pixel Strobe Line

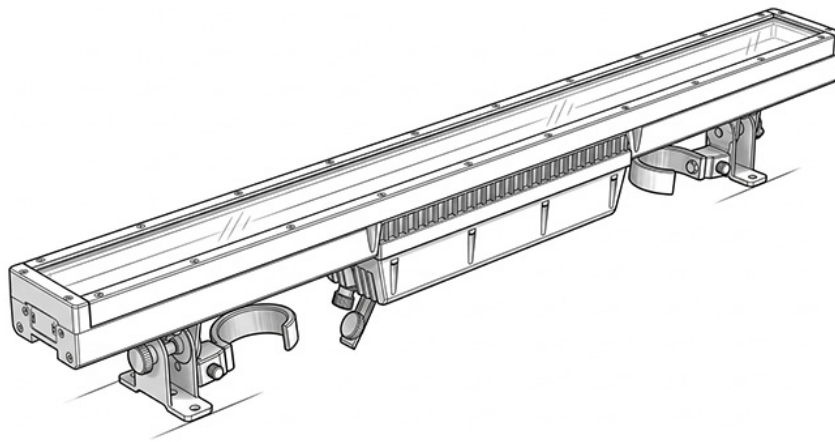

FXLIGHTING
FX-LIGHTING.COM

User Manual

Please read carefull before use

CONTENTS

01/ Safety Instructions.....	2
02/ Technical Specifications	6
03/ Control Panel.....	8
04/ Fixture Installation.....	9
05/ How To Set The Unit.....	14
5.1 Main Functions	14
5.2 Home Position Adjustment	25
06/ Control By Universal DMX Controller.....	29
6.1 DMX512 Connection.....	29
6.2 Address Setting.....	30
6.3 DMX512 Configuration	31
07/ Error Information	64
08/ Troubleshooting	65
09/ Fixture Cleaning.....	65

01/ Safety Instructions



Please read the instruction carefully which includes important information about the installation, usage and maintenance.

WARNING

Please keep this User Guide for future consultation. If you sell the unit to another user, be sure that they also receive this instruction manual.

Important:

Damages caused by the disregard of this user manual are not subject to warranty. The dealer will not accept liability for any resulting defects or problems.

- Unpack and check carefully to ensure that there is no transportation damage before using the unit.
- This product is suitable for wet locations. Do not immerse in water.
- DO install and operate by qualified operator.
- DO NOT allow children to operate the fixture.
- Use safety chain when fixing the unit. Handle the unit by carrying its base instead of head only.
- The unit must be installed in a location with adequate ventilation, at least 50cm from adjacent surfaces.
- Be sure that no ventilation slots is blocked, otherwise the unit will be overheated.
- Before operation, ensure that you are connecting this product to the proper voltage in accordance with the specifications in this manual or on the product's specification label.
- It's important to ground the yellow/green conductor to earth in order to avoid electric shock.
- Minimum ambient temperature TA: 0°C. Maximum ambient temperature TA: 40°C. Do not operate this product at a lower or higher temperature.
- DO NOT connect the device to any dimmer pack.
- Keep flammable materials away from the fixture while operating to avoid fire hazard.
- Make sure the power cord is not crimped or damaged; replace it immediately if damaged.
- Unit's surface temperature may reach up to 65°C. DO NOT touch the housing bare-handed during its operation.
- Avoid any flammable liquids, water or metal from entering the unit. Once it happens, cut

off the mains power immediately.

- DO NOT operate in a dirty or dusty environment. DO clean the fixture regularly.
- DO NOT touch any wire during operation as there might be a hazard of electric shock.
- Avoid entanglement of the power cord with other wires.
- The minimum distance to objects/surface must be more than 0.5 meters.
- In the event of serious operating problem, stop using the unit immediately.
- Never turn on and off the unit time after time.
- The housing, the lenses, or the ultraviolet filter must be replaced if they are visibly damaged.
- DO NOT open the housing as there are no user serviceable parts inside.
- DO NOT attempt to operate this unit if it becomes damaged. DO NOT attempt any repairs yourself. Repairs carried out by unskilled people can lead to damage or malfunction. Please contact the nearest authorized technical assistance center if needed.
- Disconnect this product from its power source before servicing.
- DO use the original packaging if the device is to be transported.
- Avoid direct eye exposure to the light source while the product is on.
- DO NOT operate this product if you see damage on the housing, shields, or cables. Have the damaged parts replaced by an authorized technician at once.

01/ Consignes de sécurité



Veillez lire attentivement les instructions qui contiennent des informations importantes sur l'installation, l'utilisation et l'entretien.

ATTENTION

Veillez conserver ce guide de l'utilisateur pour une consultation future. Si vous vendez l'appareil à un autre utilisateur, assurez-vous qu'il reçoive également ce manuel d'instructions.

Important:

Les dommages causés par le non-respect de ce manuel d'utilisation ne sont pas couverts par la garantie. Le revendeur n'acceptera aucune responsabilité pour les défauts ou problèmes qui en résultent.

- Déballez et vérifiez soigneusement qu'il n'y a pas de dommages dus au transport avant d'utiliser l'appareil.
- Ce produit convient aux endroits humides. Ne pas immerger dans l'eau.
- L'installation et la mise en fonctionnement doit être effectué par un opérateur qualifié.
- NE PAS permettre aux enfants d'utiliser l'appareil.
- Utilisez une chaîne de sécurité lors de la fixation de l'unité. Manipulez l'appareil en portant sa base au lieu de la tête uniquement.
- L'unité doit être installée dans un endroit avec une ventilation adéquate, à au moins 50cm des surfaces adjacentes.
- Assurez-vous qu'aucune fente d'aération du luminaire n'est obstruée, sinon il risque de surchauffer.
- Avant toute utilisation, assurez-vous que vous connectez ce luminaire à la tension appropriée conformément aux spécifications que vous trouverez dans ce manuel ou sur l'étiquette des spécifications collée sur la base du luminaire.
- Il est important de relier le file jaune/vert à la terre afin d'éviter tout choc électrique.
- Température ambiante minimale TA: 0°C. Température ambiante maximale TA: 40°C. N'utilisez pas ce luminaire à des températures inférieures ou supérieures.
- NE PAS connecter le luminaire à un pack de gradateurs.
- Gardez les matériaux inflammables à l'écart du luminaire pendant le fonctionnement pour éviter tout risque d'incendie.

- Assurez-vous que le cordon d'alimentation n'est pas pincé ou endommagé; remplacez-le immédiatement s'il est endommagé.
- La température de surface de l'unité peut atteindre 65°C. NE PAS toucher les capots à mains nues pendant son fonctionnement.
- Évitez que des liquides inflammables, de l'eau ou du métal ne pénètrent dans l'appareil. Si cela se produit, coupez immédiatement l'alimentation secteur.
- NE PAS utiliser le luminaire dans un environnement sale ou poussiéreux. Cette appareil doit être nettoyer régulièrement.
- NE touchez AUCUN file pendant le fonctionnement car il pourrait y avoir un risque de choc électrique.
- Évitez l'enchevêtrement du cordon d'alimentation avec d'autres fils.
- La distance minimale de projection sur des objets ou sur des surfaces doit être supérieure à 0.5 mètres.
- En cas de problème de fonctionnement grave, arrêtez immédiatement d'utiliser l'appareil.
- N'allumez et n'éteignez jamais ce luminaire à maintes reprises.
- Le boîtier, les lentilles ou le filtre ultraviolet doivent être remplacés s'ils sont visiblement endommagés.
- NE PAS ouvrir le boîtier car il ne contient aucune pièce réparable par l'utilisateur.
- NE PAS mettre ce luminaire en fonctionnement s'il est endommagé. N'effectuez pas de réparations vous-même. Les réparations ne doivent être effectuées par des personnes non qualifiées, cela peut entraîner des dommages ou des dysfonctionnements. Veuillez contacter le centre d'assistance technique agréé le plus proche si nécessaire.
- Débranchez ce produit du secteur avant de procéder à l'entretien.
- Utiliser l'emballage d'origine si l'appareil doit être transporté.
- Évitez une exposition directe des yeux à la source lumineuse lorsque le produit est allumé.
- N'utilisez PAS ce produit si vous constatez des dommages sur le boîtier, les blindages ou les câbles. Faites remplacer immédiatement les pièces endommagées par un technicien agréé.

02/ Technical Specifications

Power Voltage	100-240V~ 50/60Hz	
Power Consumption	420W	
Light Source	672x0.5W RGB LED	
	112x3W CW LED	
Beam Angle	101° (RGB)	
	108° (CW)	
Field Angle	149° (RGB)	
	152° (CW)	
Dimmer/Strobe	0-100% smooth dimming; High output strobe effect	
Control	DMX Channel	7/15/21/39/112/17/33/65/68/117/70 Channels
	Control Mode	DMX512
		RDM
		Art-Net
		sACN
Firmware Upgrade	Firmware Upgrade via DMX link	
Construction	Display	OLED display
	Data In/Out	5-pin IP XLR (3-pin IP XLR is optional)
		RJ45 Connector
	Power In/Out	Waterproof Power Connector in/out
Protection Rating	IP66	
<p><i>Description for power cord set should be used: Listed 5-15P or 6-15P plug molded with SJTW flexible cord with rating: 300V, 105°C, VW-1, 16AWGx3C, molded with attachment plug and cord connector model SAC3FX with rating 250VAC, 16A by NINGBO HAISHU DISTRICT SEETRONIC ELECTRONIC CO. LTD. The length of power cord shall be at least 914mm (It is to be measured from the face of the attachment plug to the face of the Cord Connector).</i></p>		
Features	32 RGB LED zones with individual control	
	16 CW LED zones with individual control	
	Outstanding color mixing effect	
	Independent frost effect	
	Equipped with an inventive quick-release mechanism that allows	

	you to quickly connect and align multiple fixtures	
	2 x sliding adjustable clamps for 50mm truss (version with sliding adjustable clamps)	
Dimensions	1000x192x237 mm (version with sliding adjustable clamps)	39.4"x7.6"x9.3"
	1000x90x124 mm (version with omega bracket holes)	39.4"x3.5"x4.9"
Weight	8.3 kg (version with sliding adjustable clamps)	18.3 lbs
	7.3 kg (version with omega bracket holes)	16.1 lbs

Version with sliding adjustable clamps:

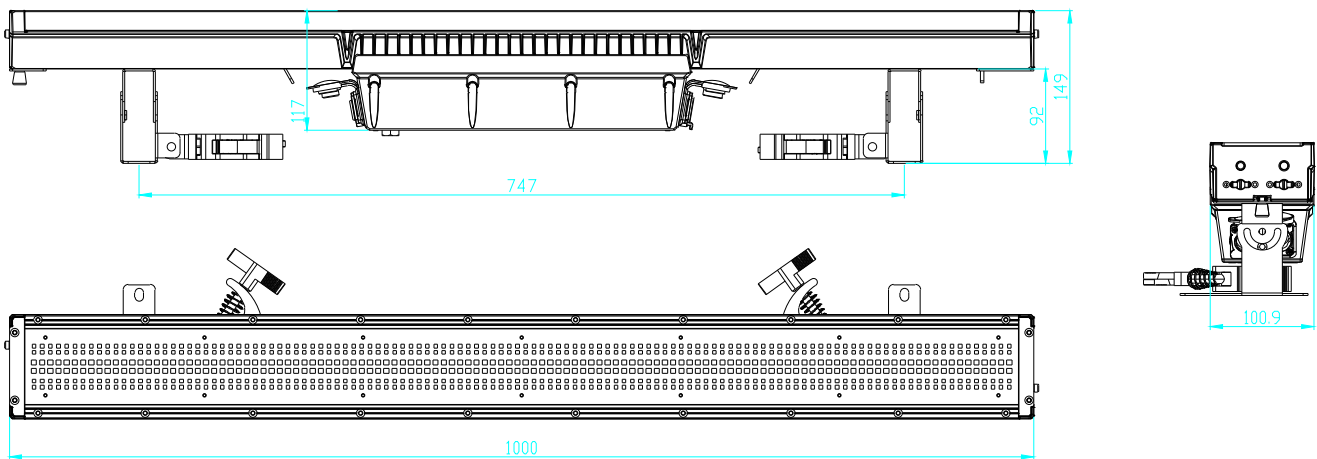

Photometric Diagram:

Beam Angle:

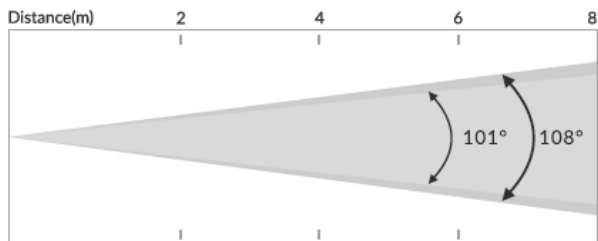

101° RGB Lux	1,163	291	129	73
Diameter(m)	12.7	25.3	38	51
108° CW Lux	2,919	730	324	182
Diameter(m)	5.7	11	16	21.7

Field Angle:

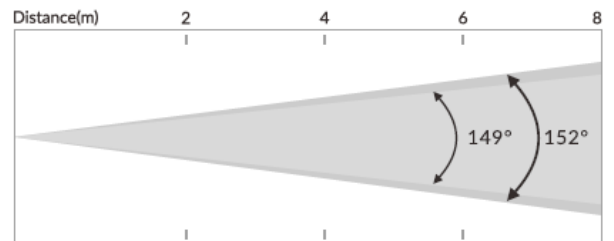

149° RGB Lux	1,163	291	129	73
Diameter(m)	14.2	28.4	42.6	56.8
152° CW Lux	2,919	730	324	182
Diameter(m)	16.4	32.8	49	61

03/ Control Panel

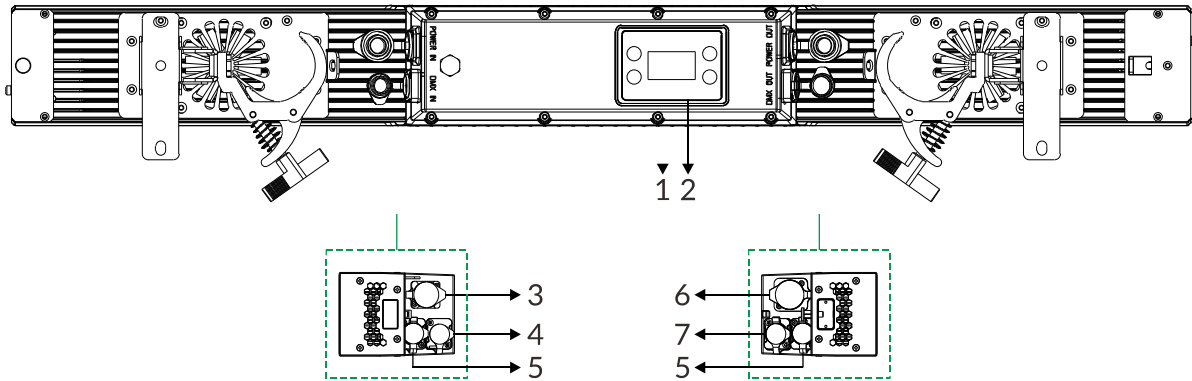

1. Display	To show the various menus and the selected function	
2. Buttons	MENU	To enter into move backward or leave the menu
	▲ UP	To go backward to move up in the menu
	▼ DOWN	To go forward to move down in the menu
	ENTER	To perform the desired functions
3. POWER IN	To connect to supply power	
4. DMX IN	For DMX512 link, use 5-pin XLR cable to link the unit and DMX controller to input DMX signal (3-pin XLR cable is optional)	
5. ETHERNET	Transfers fixture's information to a main controller	
6. POWER OUT	To connect to the next fixture	
7. DMX OUT	For DMX512 link, use 5-pin XLR cable to link the next units to output DMX signal (3-pin XLR cable is optional)	

04/ Fixture Installation

- ▶ DO install and operate by qualified operator. Fixture(s) should be installed in areas outside walking paths, seating areas, or away from areas where unauthorized personnel might reach the fixture by hand. NEVER stand directly below the fixture(s) when rigging, removing or servicing.
- ▶ Always ensure that the unit is firmly fixed to avoid vibration and slipping off during operation. Ensure that the trussing or area of installation must be able to hold 10 times the weight without any deformation. Always attach a safety cable that can hold at least 12 times the weight of the fixture whenever installing this fixture in a suspended environment to ensure that the fixture will not fall if the clamp fails.
- ▶ This fixture is fully operational in three different mounting positions: hanging on trussing, mounted sideways on trussing, or standing on the floor. Always use and install a safety cable as a safety measure to prevent accidental damage and/or injury in the event the clamp fails.

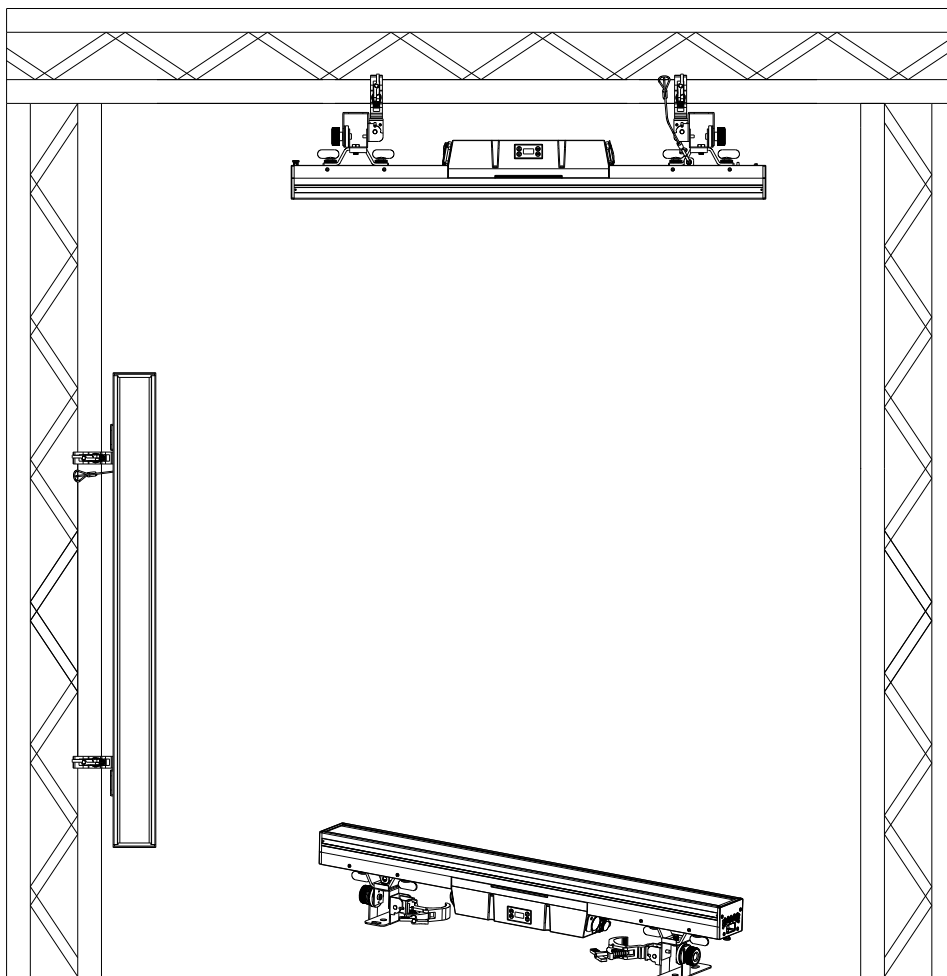

Hanging the fixture:

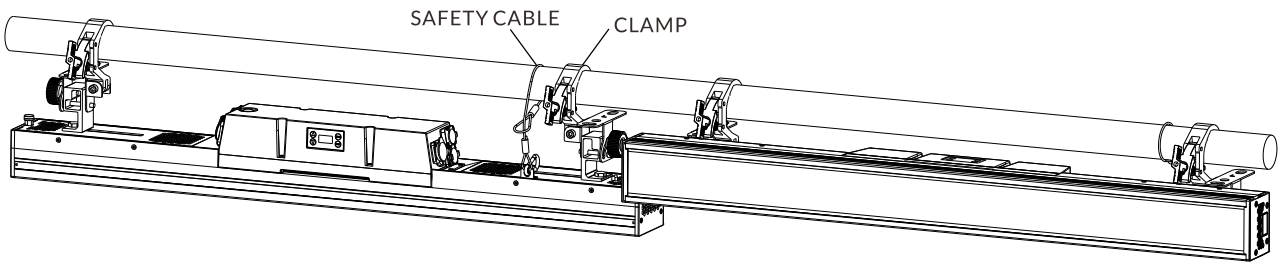

Stand the fixture on the floor:

1. Drill four expansion screw holes (for M12 expansion screws) on the ground or a wall according to the size shown in Figure ①.
2. As shown in Figure ②, unscrew the washers and nuts of the expansion screws, and insert the expansion screw tubes and screws into the drilled screw holes.
3. As shown in Figure ③, align the holes on the brackets of the fixture with the four screws, then put the washers and nuts of the expansion screws in turn and tighten them with a wrench.
4. After tightening the nuts, check whether the fixture is installed firmly, then adjust the fixture to the required angle through the bracket knob.

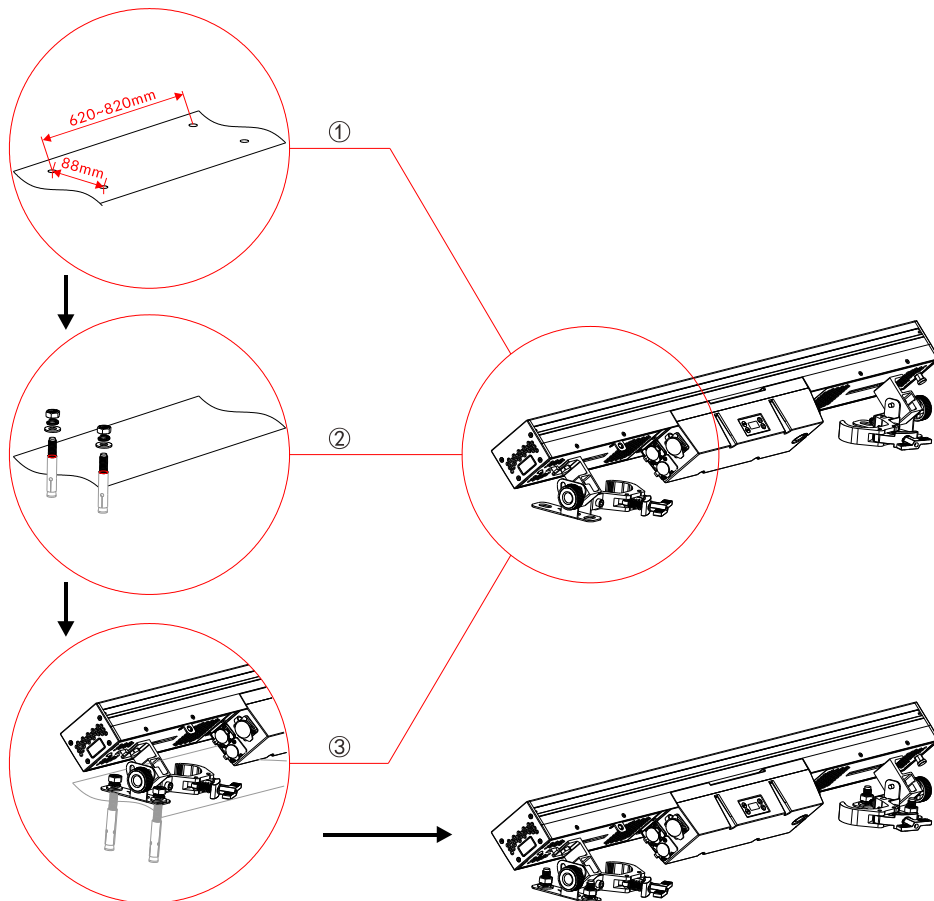

05/ How To Set The Unit

5.1 Main Functions

- ▶ To access the control menus, press the [MENU] button.
- ▶ Navigate the menu structure, using the [ENTER], [▲ UP] and [▼ DOWN] buttons.
- ▶ To select a menu option or to confirm a selection, press the [ENTER] button.
- ▶ To return to a higher level in the menu structure without making a change, press the [MENU] button, or wait 30 seconds.

The screen will be automatically locked if there is no operation for a long time, and can be unlocked by long-pressing the [MENU] button.

The main functions are shown below:

MENU	SUBMENU	OPTIONS		
DMX Settings	DMX Address	1-506 (7 CH)	(Default=1)	
		1-498 (15 CH)		
		1-492 (21 CH)		
		1-474 (39 CH)		
		1-401 (112 CH)		
		1-496 (17 CH)		
		1-480 (33 CH)		
		1-448 (65 CH)		
		1-445 (68 CH)		
		1-396 (117 CH)		
	1-443 (70 CH)			
	Channel Mode	7 CH		
		15 CH		
		21 CH		
		39 CH		
		112 CH		
		17 CH		
		33 CH		
		65 CH		
		68 CH		
117 CH				
70 CH				

MENU	SUBMENU	OPTIONS		
	No DMX Status	Hold		
		Blackout		
		Manual		
	View DMX Value			
	Connect Option	Auto		
		DMX		
		Art-Net		
		sACN		
	Network	IP Address	XXX.XXX.XXX.XXX	
		Subnet Mask	XXX.XXX.XXX.XXX	
	Art-Net Settings	Net	0-127	(Default=0)
		Sub-Net	0-15	(Default =0)
		Universe	0-15	(Default =0)
sACN Settings	sACN Universe	1-32000	(Default =1)	
	sACN Priority	0-200	(Default =100)	
Fixture Settings	Dimmer Curve	Linear		
		Square Law		
		Inv SQ Law		
		S Curve		
	Dimmer Speed	Fast		
		Smooth		
	White Balance	Red 1	125-255	
		Green 1	125-255	
		Blue 1	125-255	
		Red 2	125-255	
		Green 2	125-255	
		Blue 2	125-255	
	Invert Pixel Order	Disable		
Enable				
Display Settings	Display Invert	No		
		Yes		
	Temperature Unit	°C		
		°F		
	Language	English		
		Chinese		

MENU	SUBMENU	OPTIONS	
Fixture Test	Auto Test		
	Manual Mode	Red	0-255
		Green	0-255
		Blue	0-255
		White	0-255
		Dimmer	0-255
		Dimmer Fine	0-255
		Duration	0-255
		Rate	0-255
Frost	0-255		
Information	Fixture Use Hour		
	LED Use Hour	Total LED Hour	
		LED On Hour	
		LED Hours Reset	Password=050
	Temperature	Current	Max temp
		LED 1	
		LED 2	
	Fan State	LED_Fan_1	
		LED_Fan_2	
	Firmware Version		
	RDM UID		
	Error Logs	Fixture Errors	
Reset Error Log		No	
		Yes	Password=050
Special Functions	Factory Restore	No	
		Yes	

DMX Settings

Enter the control menu and select **DMX Settings**, press ENTER. Use the UP/DOWN button to select **DMX Address**, **Channel Mode**, **No DMX Status**, **View DMX Value**, **Connect Option**, **Network**, **Art-Net Settings** or **sACN Settings**.

DMX Address

Select **DMX Address**, press ENTER.

Use UP/DOWN button to select an address, confirm your selection with ENTER.

CHANNEL MODE	DMX ADDRESS
7 CH	1-506
15 CH	1-498
21 CH	1-492
39 CH	1-474
112 CH	1-401
17 CH	1-496
33 CH	1-480
65 CH	1-448
68 CH	1-445
117 CH	1-396
70 CH	1-443

To exit the menu, press MENU, or wait 30 seconds.

Channel Mode

Select **Channel Mode**, press ENTER.

Use UP/DOWN button to select between **7 CH**, **15 CH**, **21 CH**, **39 CH**, **112 CH**, **17 CH**, **33 CH**, **65 CH**, **68 CH**, **117 CH** and **70 CH**, confirm your selection with ENTER.

To exit the menu, press MENU, or wait 30 seconds.

No DMX Status

Select **No DMX Status**, press ENTER.

Use UP/DOWN button to select one of the following status:

Hold (The device continues to operate in the current mode with the last active DMX values until the signal returns)

Blackout (Fixture blacks out if DMX signal stops)

Manual (The device accepts the DMX value stored in the 'Manual Mode' menu)

Confirm your selection with ENTER.

To exit the menu, press MENU, or wait 30 seconds.

View DMX Value

Select **View DMX Value**, press ENTER.

Use UP/DOWN button to select the desired DMX channel, for which the value is to be displayed.

To exit the menu, press MENU, or wait 30 seconds.

Connect Option

Select **Connect Option**, press ENTER.

Use UP/DOWN button to select **Auto**, **DMX**, **Art-Net** or **sACN**, confirm your selection with ENTER.

To exit the menu, press MENU, or wait 30 seconds.

Network

Select **Network**, press ENTER.

Use UP/DOWN button to select **IP Address** or **Subnet Mask**, confirm your selection with ENTER.

To exit the menu, press MENU, or wait 30 seconds.

Art-Net Settings

Select **Art-Net Settings**, press ENTER.

Use UP/DOWN button to select **Net**, **Sub-Net** or **Universe**, confirm your selection with ENTER.

To exit the menu, press MENU, or wait 30 seconds.

sACN Settings

Select **sACN Settings**, press ENTER.

Use UP/DOWN button to select **sACN Universe** or **sACN Priority**, confirm your selection with ENTER.

To exit the menu, press MENU, or wait 30 seconds.

Fixture Settings

Enter the control menu and select **Fixture Settings**, press ENTER. Use the UP/DOWN button to select **Dimmer Curve**, **Dimmer Speed**, **White Balance** or **Invert Pixel Order**.

Dimmer Curve

Select **Dimmer Curve**, press ENTER.

Use UP/DOWN button to select **Linear**, **Square Law**, **Inv SQ Law** or **S Curve**, confirm your selection with ENTER.

Dimmer Modes

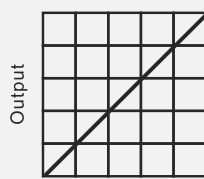

Optically Linear

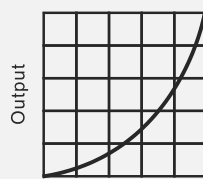

Square Law

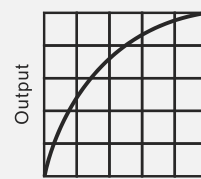

Inverse Square Law

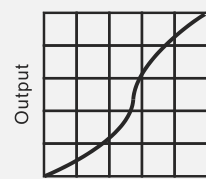

S-curve

To exit the menu, press MENU, or wait 30 seconds.

Dimmer Speed

Select **Dimmer Speed**, press ENTER.

Use UP/DOWN button to select **Fast** or **Smooth**, confirm your selection with ENTER.

To exit the menu, press MENU, or wait 30 seconds.

White Balance

Select **White Balance**, press ENTER.

Use UP/DOWN button to select **Red 1, Green 1, Blue 1** or **Red 2, Green 2, Blue 2**, confirm your selection with ENTER.

Use UP/DOWN button to select a value between **125** and **255**, confirm your selection with ENTER.

To exit the menu, press MENU, or wait 30 seconds.

Invert Pixel Order

Select **Invert Pixel Order**, press ENTER.

Use UP/DOWN button to select **Disable** or **Enable**, confirm your selection with ENTER.

To exit the menu, press MENU, or wait 30 seconds.

Display Settings

Enter the control menu and select **Display Settings**, press ENTER. Use the UP/DOWN button to select **Display Invert, Temperature Unit** or **Language**.

Display Invert

Select **Display Invert**, press ENTER.

Use UP/DOWN button to select **No** (display normal) or **Yes** (display inverted), confirm your selection with ENTER.

To exit the menu, press MENU, or wait 30 seconds.

Temperature Unit

Select **Temperature Unit**, press ENTER.

Use UP/DOWN button to select **°C** or **°F**, confirm your selection with ENTER.

To exit the menu, press MENU, or wait 30 seconds.

Language

Select **Language**, press ENTER.

Use UP/DOWN button to select **English** or **Chinese**, confirm your selection with ENTER.

To exit the menu, press MENU, or wait 30 seconds.

Fixture Test

Enter the control menu and select **Fixture Test**, press ENTER. Use the UP/DOWN button to select **Auto Test** or **Manual Mode**.

Auto Test

Select **Auto Test**, press ENTER.

The device immediately performs an automatic self-test.

To end the automatic self-test and exit the menu, press MENU, or wait 30 seconds.

Manual Mode

Select **Manual Mode**, press ENTER.

Use UP/DOWN button to select the channel for which the manual test is to be performed, confirm your selection with ENTER.

Use UP/DOWN button to select a value, confirm your selection with ENTER.

To exit the menu, press MENU, or wait 30 seconds.

(The device returns to its original DMX state after the manual test. The test values are saved automatically when the device is switched off.)

Information

Enter the control menu and select **Information**, press ENTER. Use the UP/DOWN button to select **Fixture Use Hour**, **LED Use Hour**, **Temperature**, **Fan State**, **Firmware Version**, **RDM UID** or **Error Logs**.

Fixture Use Hour

Select **Fixture Use Hour**, press ENTER.
The operating hours is displayed.
To exit the menu, press MENU, or wait 30 seconds.

LED Use Hour

Select **LED Use Hour**, press ENTER.
Use UP/DOWN button to select **Total LED Hour** (total time) or **LED On Hour** (current switch-on time), confirm your selection with ENTER.
The total time or current switch-on time is displayed.
Use UP/DOWN button to select **LED Hours Reset**, confirm your selection with ENTER.
Use UP/DOWN button to set the password 050, confirm your selection with ENTER. The LED operating hours is reset.
To exit the menu, press MENU, or wait 30 seconds.

Temperature

Select **Temperature**, press ENTER.
The device temperature is displayed.
To exit the menu, press MENU, or wait 30 seconds.

Fan State

Select **Fan State**, press ENTER.
The fan status is displayed.
To exit the menu, press MENU, or wait 30 seconds.

Firmware Version

Select **Firmware Version**, press ENTER.

The firmware version is displayed.

To exit the menu, press MENU, or wait 30 seconds.

RDM UID

Select **RDM UID**, press ENTER.

The RDM UID is displayed.

To exit the menu, press MENU, or wait 30 seconds.

Error Logs

Select **Error Logs**, press ENTER.

Use UP/DOWN button to select **Fixture Errors**, confirm your selection with ENTER.

The error list is displayed.

Use UP/DOWN button to select **Reset Error Log**, confirm your selection with ENTER.

If you wish to reset the relevant error logs, select **Yes**. If you do not wish to reset anything, select **No**. Confirm your selection with ENTER.

If you select **Yes**, use UP/DOWN button to set the password 050, confirm your selection with ENTER. The relevant error logs are reset.

To exit the menu, press MENU, or wait 30 seconds.

Special Functions

Enter the control menu and select **Special Functions**, press ENTER. Use the UP/DOWN button to select **Factory Restore**.

Factory Restore

Select **Factory Restore**, press ENTER.

If you wish to reset the device to the factory settings, select **Yes**. If you do not wish to reset anything, select **No**. Confirm your selection with ENTER.

To exit the menu, press MENU, or wait 30 seconds.

RDM functions: Certain menus of the device and functions can be called up via the RDM protocol.

The parameter IDs are implemented as follows for different commands:

Parameter ID	Command 'Discovery'	Command 'Set'	Command 'Get'
DISC_UNIQUE_BRANCH	√		
DISC_MUTE	√		
DISC_UN_MUTE	√		
DEVICE_INFO			√
SUPPORTED_PARAMETERS			√
SOFTWARE_VERSION_LABEL			√
DMX_START_ADDRESS		√	√
IDENTIFY_DEVICE		√	√
DEVICE_MODEL_DESCRIPTION			√
PARAMETER_DESCRIPTION			√
MANUFACTURER_LABEL			√
DEVICE_LABEL		√	√
FACTORY_DEFAULTS		√	√
BOOT_SOFTWARE_VERSION_ID			√
BOOT_SOFTWARE_VERSION_LABEL			√
DMX_PERSONALITY		√	√
DMX_PERSONALITY_DESCRIPTION			√
SENSOR_DEFINITION			√
SENSOR_VALUE			√
DEVICE_HOURS			√
RESET_DEVICE		√	

√ -Command implemented for the respective parameter ID

5.2 Home Position Adjustment

- ▶ To access the control menus, press the [MENU] button.
- ▶ To access the offset menus, long-press the [ENTER] button.
- ▶ Navigate the offset menus, using the [ENTER], [▲ UP] and [▼ DOWN] buttons.
- ▶ To select a menu option or to confirm a selection, press the [ENTER] button.
- ▶ To return to a higher level in the menu structure without making a change, press the [MENU] button, or wait 30 seconds.

OFFSET MENU	VALUES
RED-A	0-255
GREEN-A	0-255
BLUE-A	0-255
WHITE-A	0-255
RED-B	0-255
GREEN-B	0-255
BLUE-B	0-255
WHITE-B	0-255
Red 1	0-255
Green 1	0-255
Blue 1	0-255
.....
Red 32	0-255
Green 32	0-255
Blue 32	0-255
White 1	0-255
.....
White 16	0-255

RED-A

Select **RED-A**, press ENTER.

Use UP/DOWN button to select a value between 0 and 255, confirm your selection with ENTER.

To exit the offset menu, press MENU, or wait 30 seconds.

GREEN-A

Select **GREEN-A**, press ENTER.

Use UP/DOWN button to select a value between 0 and 255, confirm your selection with ENTER.

To exit the offset menu, press MENU, or wait 30 seconds.

BLUE-A

Select **BLUE-A**, press ENTER.

Use UP/DOWN button to select a value between 0 and 255, confirm your selection with ENTER.

To exit the offset menu, press MENU, or wait 30 seconds.

WHITE-A

Select **WHITE-A**, press ENTER.

Use UP/DOWN button to select a value between 0 and 255, confirm your selection with ENTER.

To exit the offset menu, press MENU, or wait 30 seconds.

RED-B

Select **RED-B**, press ENTER.

Use UP/DOWN button to select a value between 0 and 255, confirm your selection with ENTER.

To exit the offset menu, press MENU, or wait 30 seconds.

GREEN-B

Select **GREEN-B**, press ENTER.

Use UP/DOWN button to select a value between 0 and 255, confirm your selection with ENTER.

To exit the offset menu, press MENU, or wait 30 seconds.

BLUE-B

Select **BLUE-B**, press ENTER.

Use UP/DOWN button to select a value between 0 and 255, confirm your selection with ENTER.

To exit the offset menu, press MENU, or wait 30 seconds.

WHITE-B

Select **WHITE-B**, press ENTER.

Use UP/DOWN button to select a value between 0 and 255, confirm your selection with ENTER.

To exit the offset menu, press MENU, or wait 30 seconds.

Red 1

Select **Red 1**, press ENTER.

Use UP/DOWN button to select a value between 0 and 255, confirm your selection with ENTER.

To exit the offset menu, press MENU, or wait 30 seconds.

Green 1

Select **Green 1**, press ENTER.

Use UP/DOWN button to select a value between 0 and 255, confirm your selection with ENTER.

To exit the offset menu, press MENU, or wait 30 seconds.

Blue 1

Select **Blue 1**, press ENTER.

Use UP/DOWN button to select a value between 0 and 255, confirm your selection with ENTER.

To exit the offset menu, press MENU, or wait 30 seconds.

.....

Red 32

Select **Red 32**, press ENTER.

Use UP/DOWN button to select a value between 0 and 255, confirm your selection with ENTER.

To exit the offset menu, press MENU, or wait 30 seconds.

Green 32

Select **Green 32**, press ENTER.

Use UP/DOWN button to select a value between 0 and 255, confirm your selection with ENTER.

To exit the offset menu, press MENU, or wait 30 seconds.

Blue 32

Select **Blue 32**, press ENTER.

Use UP/DOWN button to select a value between 0 and 255, confirm your selection with ENTER.

To exit the offset menu, press MENU, or wait 30 seconds.

White 1

Select **White 1**, press ENTER.

Use UP/DOWN button to select a value between 0 and 255, confirm your selection with ENTER.

To exit the offset menu, press MENU, or wait 30 seconds.

.....

White 16

Select **White 16**, press ENTER.

Use UP/DOWN button to select a value between 0 and 255, confirm your selection with ENTER.

To exit the offset menu, press MENU, or wait 30 seconds.

6.1 DMX512 Connection

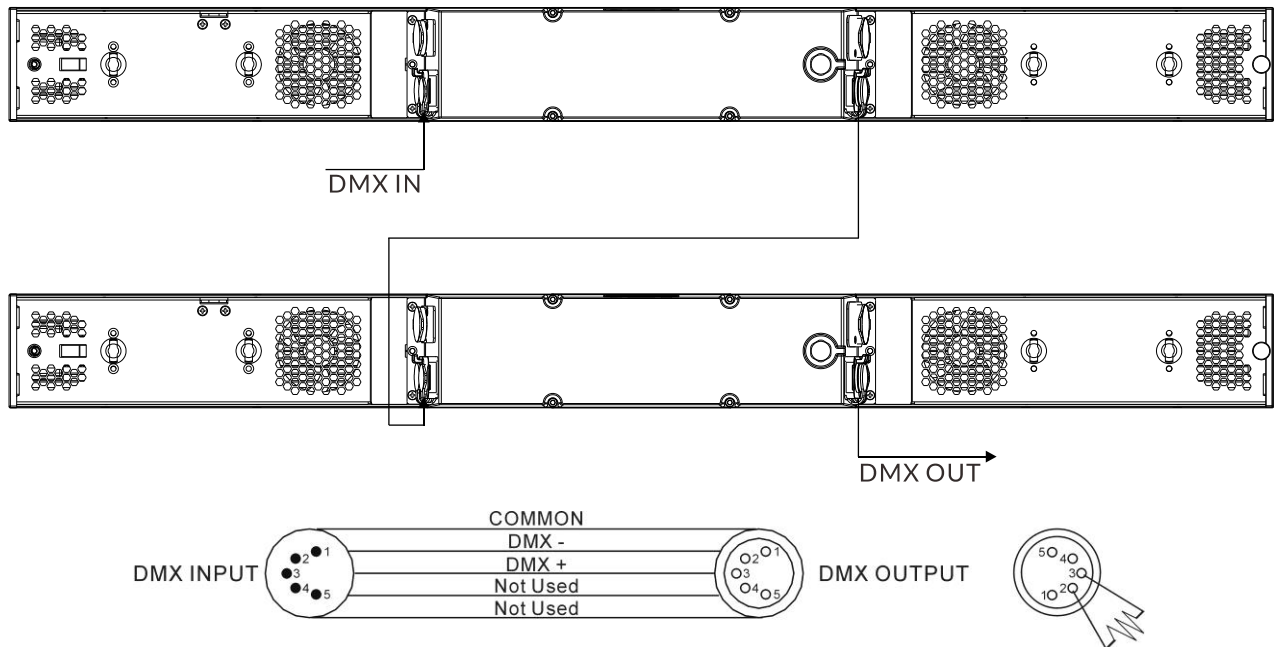

1. At last unit, the DMX cable has to be terminated with a terminator. Solder a 120-ohm 1/4W resistor between pin 2(DMX-) and pin 3(DMX+) into a 3-pin XLR-plug and plug it in the DMX-output of the last unit.
2. Connect the unit together in a “daisy chain” by XLR plug cable from the output of the unit to the input of the next unit. The cable can only be used in series and cannot be connected in parallel. DMX 512 is a very high-speed signal. Inadequate or damaged cables, soldered joints or corroded connectors can easily distort the signal and shut down the system.
3. The DMX output and input connectors are pass-through to maintain the DMX circuit, when one of the units' power is disconnected.
4. Each lighting unit needs to have a DMX address to receive the data by the controller. The address number is between 1-512.
5. The end of the DMX 512 system should be terminated to reduce signal errors.
6. When wiring 3 pin XLR connectors: Pin 1: GND, Pin 2: Negative signal (-), Pin 3: Positive signal (+). When wiring 5 pin XLR connectors: Pin 1: GND, Pin 2: Negative signal (-), Pin 3: Positive signal (+), Pin4, Pin5 not used.

6.2 Address Setting

If you use a universal DMX controller to control the units, you have to set DMX address between 1 and 512 so that the units can receive DMX signal.

Press the MENU button to access the control menus, select DMX Settings, press the ENTER button to confirm. Use the UP/DOWN button to select DMX Address, press the ENTER button to confirm, the present address will show on the display. Use the UP/DOWN button to adjust the address between 001 and 512, press the ENTER button to store. To exit the menu, press MENU, or wait 30 seconds.

Please refer to the following diagram to address your DMX512 channel for the first 4 units.

Channel Mode	Unit 1 Address	Unit 2 Address	Unit 3 Address	Unit 4 Address
7 channels	1	8	15	22
15 channels	1	16	31	46
21 channels	1	22	43	64
39 channels	1	40	79	118
112 channels	1	113	225	337
17 channels	1	18	35	52
33 channels	1	34	67	100
65 channels	1	66	131	196
68 channels	1	69	137	205
117 channels	1	118	235	352
70 channels	1	71	141	211

6.3 DMX512 Configuration

Please control the fixture by referring to the configurations below.

Attentions:

- ▶ The unit will maintain the last condition until reset if you cut-off the DMX signal.
- ▶ For the channel Function, keep the value for about 3 seconds, then the corresponding function will take into effect.

7 Channels (Mode 1):

CHANNEL	VALUE	FUNCTION
1	000-255	RED 0%→100%
2	000-255	GREEN 0%→100%
3	000-255	BLUE 0%→100%
4	000-255	WHITE 0%→100%
5	000-005 006-255	DIMMER Null 0%→100%
6	000-255	DIMMER FINE
7	000-255	FROST 0%→100%

15 Channels (Mode 2):

CHANNEL	VALUE	FUNCTION
1	000-255	RED 0%→100%
2	000-255	GREEN 0%→100%
3	000-255	BLUE 0%→100%
4	000-255	WHITE 0%→100%
5	000-009 010-017 018-024	COLOR MACRO Null Color 1 Color 2

	025-032 033-039 040-047 048-054 055-061 062-069 070-076 077-084 085-091 092-099 100-106 107-113 114-121 122-128 129-136 137-143 144-151 152-158 159-165 166-173 174-180 181-188 189-195 196-203 204-210 211-217 218-225 226-232 233-240 241-247 248-255	Color 3 Color 4 Color 5 Color 6 Color 7 Color 8 Color 9 Color 10 Color 11 Color 12 Color 13 Color 14 Color 15 Color 16 Color 17 Color 18 Color 19 Color 20 Color 21 Color 22 Color 23 Color 24 Color 25 Color 26 Color 27 Color 28 Color 29 Color 30 Color 31 Color 32 Color 33
6	000-005 006-255	DIMMER Null 0%→100%
7	000-255	DIMMER FINE
8	000-255	STROBE DURATION
9	000-006 007-255	STROBE RATE Blackout Strobe from Slow to Fast
10	000-005 006-050 051-100 101-150 151-200 201-255	STROBE Null Ramp up Ramp down Ramp up-down Lightning Random

11	000-023 024-031 032-039 040-047 048-055 056-063 064-071 072-079 080-087 088-095 096-103 104-111 112-119 120-127 128-135 136-143 144-151 152-159 160-167 168-175 176-183 184-191 192-199 200-207 208-215 216-223 224-231 232-239 240-247 248-255	MACRO (RGB) Null Macro 1 Macro 2 Macro 3 Macro 4 Macro 5 Macro 6 Macro 7 Macro 8 Macro 9 Macro 10 Macro 11 Macro 12 Macro 13 Macro 14 Macro 15 Macro 16 Macro 17 Macro 18 Macro 19 Macro 20 Macro 21 Macro 22 Macro 23 Macro 24 Macro 25 Macro 26 Macro 27 Macro 28 Macro 29
12	000-090 091-105 106-120 121-135 136-150 151-165 166-180 181-195 196-210 211-225 226-240 241-255	MACRO (W) Null Macro 1 Macro 2 Macro 3 Macro 4 Macro 5 Macro 6 Macro 7 Macro 8 Macro 9 Macro 10 Macro 11
13	000-127 128-255	MACRO SPEED Normal, Slow to Fast Inversion, Slow to Fast

14	000-255	FADE 0%→100%
15	000-255	FROST 0%→100%

21 Channels (Mode 3):

CHANNEL	VALUE	FUNCTION
1	000-255	RED 0%→100%
2	000-255	GREEN 0%→100%
3	000-255	BLUE 0%→100%
4		COLOR MACRO
	000-009	Null
	010-017	Color 1
	018-024	Color 2
	025-032	Color 3
	033-039	Color 4
	040-047	Color 5
	048-054	Color 6
	055-061	Color 7
	062-069	Color 8
	070-076	Color 9
	077-084	Color 10
	085-091	Color 11
	092-099	Color 12
	100-106	Color 13
	107-113	Color 14
	114-121	Color 15
	122-128	Color 16
	129-136	Color 17
	137-143	Color 18
	144-151	Color 19
	152-158	Color 20
	159-165	Color 21
	166-173	Color 22
	174-180	Color 23
	181-188	Color 24
	189-195	Color 25
	196-203	Color 26
	204-210	Color 27
	211-217	Color 28
	218-225	Color 29
226-232	Color 30	

	233-240 241-247 248-255	Color 31 Color 32 Color 33
5	000-005 006-255	DIMMER (RGB) Null 0%→100%
6	000-255	DIMMER FINE (RGB)
7	000-255	STROBE DURATION (RGB)
8	000-006 007-255	STROBE RATE (RGB) Blackout Strobe from Slow to Fast
9	000-005 006-050 051-100 101-150 151-200 201-255	STROBE (RGB) Null Ramp up Ramp down Ramp up-down Lightning Random
10	000-023 024-031 032-039 040-047 048-055 056-063 064-071 072-079 080-087 088-095 096-103 104-111 112-119 120-127 128-135 136-143 144-151 152-159 160-167 168-175 176-183 184-191 192-199 200-207 208-215 216-223 224-231	MACRO (RGB) Null Macro 1 Macro 2 Macro 3 Macro 4 Macro 5 Macro 6 Macro 7 Macro 8 Macro 9 Macro 10 Macro 11 Macro 12 Macro 13 Macro 14 Macro 15 Macro 16 Macro 17 Macro 18 Macro 19 Macro 20 Macro 21 Macro 22 Macro 23 Macro 24 Macro 25 Macro 26

	232-239 240-247 248-255	Macro 27 Macro 28 Macro 29
11	000-127 128-255	MACRO SPEED (RGB) Normal, Slow to Fast Inversion, Slow to Fast
12	000-255	FADE (RGB) 0%→100%
13	000-005 006-255	DIMMER (W) Null 0%→100%
14	000-255	DIMMER FINE (W)
15	000-255	STROBE DURATION (W)
16	000-006 007-255	STROBE RATE (W) Blackout Strobe from Slow to Fast
17	000-005 006-050 051-100 101-150 151-200 201-255	STROBE (W) Null Ramp up Ramp down Ramp up-down Lightning Random
18	000-090 091-105 106-120 121-135 136-150 151-165 166-180 181-195 196-210 211-225 226-240 241-255	MACRO (W) Null Macro 1 Macro 2 Macro 3 Macro 4 Macro 5 Macro 6 Macro 7 Macro 8 Macro 9 Macro 10 Macro 11
19	000-127 128-255	MACRO SPEED (W) Normal, Slow to Fast Inversion, Slow to Fast
20	000-255	FADE (W) 0%→100%
21	000-255	FROST 0%→100%

39 Channels (Mode 4):

CHANNEL	VALUE	FUNCTION
1	000-255	RED 1 0%→100%
2	000-255	GREEN 1 0%→100%
3	000-255	BLUE 1 0%→100%
4	000-255	RED 2 0%→100%
5	000-255	GREEN 2 0%→100%
6	000-255	BLUE 2 0%→100%
7	000-255	RED 3 0%→100%
8	000-255	GREEN 3 0%→100%
9	000-255	BLUE 3 0%→100%
10	000-255	RED 4 0%→100%
11	000-255	GREEN 4 0%→100%
12	000-255	BLUE 4 0%→100%
13	000-255	RED 5 0%→100%
14	000-255	GREEN 5 0%→100%
15	000-255	BLUE 5 0%→100%
16	000-255	RED 6 0%→100%
17	000-255	GREEN 6 0%→100%
18	000-255	BLUE 6 0%→100%
19	000-255	RED 7 0%→100%
20	000-255	GREEN 7 0%→100%
21		BLUE 7

	000-255	0%→100%
22	000-255	RED 8 0%→100%
23	000-255	GREEN 8 0%→100%
24	000-255	BLUE 8 0%→100%
25	000-005 006-255	DIMMER (RGB) Null 0%→100%
26	000-255	DIMMER FINE (RGB)
27	000-255	STROBE DURATION (RGB)
28	000-006 007-255	STROBE RATE (RGB) Blackout Strobe from Slow to Fast
29	000-005 006-050 051-100 101-150 151-200 201-255	STROBE (RGB) Null Ramp up Ramp down Ramp up-down Lightning Random
30	000-255	WHITE 1 0%→100%
31	000-255	WHITE 2 0%→100%
32	000-255	WHITE 3 0%→100%
33	000-255	WHITE 4 0%→100%
34	000-005 006-255	DIMMER (W) Null 0%→100%
35	000-255	DIMMER FINE (W)
36	000-255	STROBE DURATION (W)
37	000-006 007-255	STROBE RATE (W) Blackout Strobe from Slow to Fast
38	000-005 006-050 051-100 101-150	STROBE (W) Null Ramp up Ramp down Ramp up-down

	151-200 201-255	Lightning Random
39	000-255	FROST 0%→100%

112 Channels (Mode 5):

CHANNEL	VALUE	FUNCTION
1	000-255	RED 1 0%→100%
2	000-255	GREEN 1 0%→100%
3	000-255	BLUE 1 0%→100%
4	000-255	RED 2 0%→100%
5	000-255	GREEN 2 0%→100%
6	000-255	BLUE 2 0%→100%
7	000-255	RED 3 0%→100%
8	000-255	GREEN 3 0%→100%
9	000-255	BLUE 3 0%→100%
10	000-255	RED 4 0%→100%
11	000-255	GREEN 4 0%→100%
12	000-255	BLUE 4 0%→100%
13	000-255	RED 5 0%→100%
14	000-255	GREEN 5 0%→100%
15	000-255	BLUE 5 0%→100%
16	000-255	RED 6 0%→100%
17	000-255	GREEN 6 0%→100%
18	000-255	BLUE 6 0%→100%

19	000-255	RED 7 0%→100%
20	000-255	GREEN 7 0%→100%
21	000-255	BLUE 7 0%→100%
22	000-255	RED 8 0%→100%
23	000-255	GREEN 8 0%→100%
24	000-255	BLUE 8 0%→100%
25	000-255	RED 9 0%→100%
26	000-255	GREEN 9 0%→100%
27	000-255	BLUE 9 0%→100%
28	000-255	RED 10 0%→100%
29	000-255	GREEN 10 0%→100%
30	000-255	BLUE 10 0%→100%
31	000-255	RED 11 0%→100%
32	000-255	GREEN 11 0%→100%
33	000-255	BLUE 11 0%→100%
34	000-255	RED 12 0%→100%
35	000-255	GREEN 12 0%→100%
36	000-255	BLUE 12 0%→100%
37	000-255	RED 13 0%→100%
38	000-255	GREEN 13 0%→100%
39	000-255	BLUE 13 0%→100%
40	000-255	RED 14 0%→100%

41	000-255	GREEN 14 0%→100%
42	000-255	BLUE 14 0%→100%
43	000-255	RED 15 0%→100%
44	000-255	GREEN 15 0%→100%
45	000-255	BLUE 15 0%→100%
46	000-255	RED 16 0%→100%
47	000-255	GREEN 16 0%→100%
48	000-255	BLUE 16 0%→100%
49	000-255	RED 17 0%→100%
50	000-255	GREEN 17 0%→100%
51	000-255	BLUE 17 0%→100%
52	000-255	RED 18 0%→100%
53	000-255	GREEN 18 0%→100%
54	000-255	BLUE 18 0%→100%
55	000-255	RED 19 0%→100%
56	000-255	GREEN 19 0%→100%
57	000-255	BLUE 19 0%→100%
58	000-255	RED 20 0%→100%
59	000-255	GREEN 20 0%→100%
60	000-255	BLUE 20 0%→100%
61	000-255	RED 21 0%→100%
62	000-255	GREEN 21 0%→100%

63	000-255	BLUE 21 0%→100%
64	000-255	RED 22 0%→100%
65	000-255	GREEN 22 0%→100%
66	000-255	BLUE 22 0%→100%
67	000-255	RED 23 0%→100%
68	000-255	GREEN 23 0%→100%
69	000-255	BLUE 23 0%→100%
70	000-255	RED 24 0%→100%
71	000-255	GREEN 24 0%→100%
72	000-255	BLUE 24 0%→100%
73	000-255	RED 25 0%→100%
74	000-255	GREEN 25 0%→100%
75	000-255	BLUE 25 0%→100%
76	000-255	RED 26 0%→100%
77	000-255	GREEN 26 0%→100%
78	000-255	BLUE 26 0%→100%
79	000-255	RED 27 0%→100%
80	000-255	GREEN 27 0%→100%
81	000-255	BLUE 27 0%→100%
82	000-255	RED 28 0%→100%
83	000-255	GREEN 28 0%→100%
84	000-255	BLUE 28 0%→100%

85	000-255	RED 29 0%→100%
86	000-255	GREEN 29 0%→100%
87	000-255	BLUE 29 0%→100%
88	000-255	RED 30 0%→100%
89	000-255	GREEN 30 0%→100%
90	000-255	BLUE 30 0%→100%
91	000-255	RED 31 0%→100%
92	000-255	GREEN 31 0%→100%
93	000-255	BLUE 31 0%→100%
94	000-255	RED 32 0%→100%
95	000-255	GREEN 32 0%→100%
96	000-255	BLUE 32 0%→100%
97	000-255	WHITE 1 0%→100%
98	000-255	WHITE 2 0%→100%
99	000-255	WHITE 3 0%→100%
100	000-255	WHITE 4 0%→100%
101	000-255	WHITE 5 0%→100%
102	000-255	WHITE 6 0%→100%
103	000-255	WHITE 7 0%→100%
104	000-255	WHITE 8 0%→100%
105	000-255	WHITE 9 0%→100%
106	000-255	WHITE 10 0%→100%

107	000-255	WHITE 11 0%→100%
108	000-255	WHITE 12 0%→100%
109	000-255	WHITE 13 0%→100%
110	000-255	WHITE 14 0%→100%
111	000-255	WHITE 15 0%→100%
112	000-255	WHITE 16 0%→100%

17 Channels (Mode 6):

CHANNEL	VALUE	FUNCTION
1	000-255	RED 1 0%→100%
2	000-255	GREEN 1 0%→100%
3	000-255	BLUE 1 0%→100%
4	000-255	RED 2 0%→100%
5	000-255	GREEN 2 0%→100%
6	000-255	BLUE 2 0%→100%
7	000-255	RED 3 0%→100%
8	000-255	GREEN 3 0%→100%
9	000-255	BLUE 3 0%→100%
10	000-255	RED 4 0%→100%
11	000-255	GREEN 4 0%→100%
12	000-255	BLUE 4 0%→100%
13	000-255	WHITE 1 0%→100%
14	000-255	WHITE 2 0%→100%

15	000-255	WHITE 3 0%→100%
16	000-255	WHITE 4 0%→100%
17	000-255	FROST 0%→100%

33 Channels (Mode 7):

CHANNEL	VALUE	FUNCTION
1	000-255	RED 1 0%→100%
2	000-255	GREEN 1 0%→100%
3	000-255	BLUE 1 0%→100%
4	000-255	RED 2 0%→100%
5	000-255	GREEN 2 0%→100%
6	000-255	BLUE 2 0%→100%
7	000-255	RED 3 0%→100%
8	000-255	GREEN 3 0%→100%
9	000-255	BLUE 3 0%→100%
10	000-255	RED 4 0%→100%
11	000-255	GREEN 4 0%→100%
12	000-255	BLUE 4 0%→100%
13	000-255	RED 5 0%→100%
14	000-255	GREEN 5 0%→100%
15	000-255	BLUE 5 0%→100%
16	000-255	RED 6 0%→100%
17	000-255	GREEN 6 0%→100%

18	000-255	BLUE 6 0%→100%
19	000-255	RED 7 0%→100%
20	000-255	GREEN 7 0%→100%
21	000-255	BLUE 7 0%→100%
22	000-255	RED 8 0%→100%
23	000-255	GREEN 8 0%→100%
24	000-255	BLUE 8 0%→100%
25	000-255	WHITE 1 0%→100%
26	000-255	WHITE 2 0%→100%
27	000-255	WHITE 3 0%→100%
28	000-255	WHITE 4 0%→100%
29	000-255	WHITE 5 0%→100%
30	000-255	WHITE 6 0%→100%
31	000-255	WHITE 7 0%→100%
32	000-255	WHITE 8 0%→100%
33	000-255	FROST 0%→100%

65 Channels (Mode 8):

CHANNEL	VALUE	FUNCTION
1	000-255	RED 1 0%→100%
2	000-255	GREEN 1 0%→100%
3	000-255	BLUE 1 0%→100%
4	000-255	RED 2 0%→100%
5	000-255	GREEN 2 0%→100%
6	000-255	BLUE 2 0%→100%
7	000-255	RED 3 0%→100%
8	000-255	GREEN 3 0%→100%
9	000-255	BLUE 3 0%→100%
10	000-255	RED 4 0%→100%
11	000-255	GREEN 4 0%→100%
12	000-255	BLUE 4 0%→100%
13	000-255	RED 5 0%→100%
14	000-255	GREEN 5 0%→100%
15	000-255	BLUE 5 0%→100%
16	000-255	RED 6 0%→100%
17	000-255	GREEN 6 0%→100%
18	000-255	BLUE 6 0%→100%
19	000-255	RED 7 0%→100%
20	000-255	GREEN 7 0%→100%
21		BLUE 7

	000-255	0%→100%
22	000-255	RED 8 0%→100%
23	000-255	GREEN 8 0%→100%
24	000-255	BLUE 8 0%→100%
25	000-255	RED 9 0%→100%
26	000-255	GREEN 9 0%→100%
27	000-255	BLUE 9 0%→100%
28	000-255	RED 10 0%→100%
29	000-255	GREEN 10 0%→100%
30	000-255	BLUE 10 0%→100%
31	000-255	RED 11 0%→100%
32	000-255	GREEN 11 0%→100%
33	000-255	BLUE 11 0%→100%
34	000-255	RED 12 0%→100%
35	000-255	GREEN 12 0%→100%
36	000-255	BLUE 12 0%→100%
37	000-255	RED 13 0%→100%
38	000-255	GREEN 13 0%→100%
39	000-255	BLUE 13 0%→100%
40	000-255	RED 14 0%→100%
41	000-255	GREEN 14 0%→100%
42	000-255	BLUE 14 0%→100%

43	000-255	RED 15 0%→100%
44	000-255	GREEN 15 0%→100%
45	000-255	BLUE 15 0%→100%
46	000-255	RED 16 0%→100%
47	000-255	GREEN 16 0%→100%
48	000-255	BLUE 16 0%→100%
49	000-255	WHITE 1 0%→100%
50	000-255	WHITE 2 0%→100%
51	000-255	WHITE 3 0%→100%
52	000-255	WHITE 4 0%→100%
53	000-255	WHITE 5 0%→100%
54	000-255	WHITE 6 0%→100%
55	000-255	WHITE 7 0%→100%
56	000-255	WHITE 8 0%→100%
57	000-255	WHITE 9 0%→100%
58	000-255	WHITE 10 0%→100%
59	000-255	WHITE 11 0%→100%
60	000-255	WHITE 12 0%→100%
61	000-255	WHITE 13 0%→100%
62	000-255	WHITE 14 0%→100%
63	000-255	WHITE 15 0%→100%
64	000-255	WHITE 16 0%→100%

65	000-255	FROST 0%→100%
----	---------	-------------------------

68 Channels (Mode 9):

CHANNEL	VALUE	FUNCTION
1	000-005 006-255	DIMMER Null 0%→100%
2	000-007 008-127 128-130 131-250 251-255	STROBE (RGB) Null Strobe from Slow to Fast Null Random Null
3	000-007 008-127 128-130 131-250 251-255	STROBE (W) Null Strobe from Slow to Fast Null Random Null
4	000-255	FROST 0%→100%
5	000-255	RED 1 0%→100%
6	000-255	GREEN 1 0%→100%
7	000-255	BLUE 1 0%→100%
8	000-255	RED 2 0%→100%
9	000-255	GREEN 2 0%→100%
10	000-255	BLUE 2 0%→100%
11	000-255	RED 3 0%→100%
12	000-255	GREEN 3 0%→100%
13	000-255	BLUE 3 0%→100%
14	000-255	RED 4 0%→100%
15		GREEN 4

	000-255	0%→100%
16	000-255	BLUE 4 0%→100%
17	000-255	RED 5 0%→100%
18	000-255	GREEN 5 0%→100%
19	000-255	BLUE 5 0%→100%
20	000-255	RED 6 0%→100%
21	000-255	GREEN 6 0%→100%
22	000-255	BLUE 6 0%→100%
23	000-255	RED 7 0%→100%
24	000-255	GREEN 7 0%→100%
25	000-255	BLUE 7 0%→100%
26	000-255	RED 8 0%→100%
27	000-255	GREEN 8 0%→100%
28	000-255	BLUE 8 0%→100%
29	000-255	RED 9 0%→100%
30	000-255	GREEN 9 0%→100%
31	000-255	BLUE 9 0%→100%
32	000-255	RED 10 0%→100%
33	000-255	GREEN 10 0%→100%
34	000-255	BLUE 10 0%→100%
35	000-255	RED 11 0%→100%
36	000-255	GREEN 11 0%→100%

37	000-255	BLUE 11 0%→100%
38	000-255	RED 12 0%→100%
39	000-255	GREEN 12 0%→100%
40	000-255	BLUE 12 0%→100%
41	000-255	RED 13 0%→100%
42	000-255	GREEN 13 0%→100%
43	000-255	BLUE 13 0%→100%
44	000-255	RED 14 0%→100%
45	000-255	GREEN 14 0%→100%
46	000-255	BLUE 14 0%→100%
47	000-255	RED 15 0%→100%
48	000-255	GREEN 15 0%→100%
49	000-255	BLUE 15 0%→100%
50	000-255	RED 16 0%→100%
51	000-255	GREEN 16 0%→100%
52	000-255	BLUE 16 0%→100%
53	000-255	WHITE 1 0%→100%
54	000-255	WHITE 2 0%→100%
55	000-255	WHITE 3 0%→100%
56	000-255	WHITE 4 0%→100%
57	000-255	WHITE 5 0%→100%
58	000-255	WHITE 6 0%→100%

59	000-255	WHITE 7 0%→100%
60	000-255	WHITE 8 0%→100%
61	000-255	WHITE 9 0%→100%
62	000-255	WHITE 10 0%→100%
63	000-255	WHITE 11 0%→100%
64	000-255	WHITE 12 0%→100%
65	000-255	WHITE 13 0%→100%
66	000-255	WHITE 14 0%→100%
67	000-255	WHITE 15 0%→100%
68	000-255	WHITE 16 0%→100%

117 Channels (Mode 10):

CHANNEL	VALUE	FUNCTION
1	000-005 006-255	DIMMER Null 0%→100%
2	000-255	STROBE DURATION
3	000-006 007-255	STROBE RATE Blackout Strobe from Slow to Fast
4	000-005 006-050 051-100 101-150 151-200 201-255	STROBE Null Ramp up Ramp down Ramp up-down Lightning Random
5	000-255	FROST 0%→100%
6	000-255	RED 1 0%→100%
7	000-255	GREEN 1 0%→100%

8	000-255	BLUE 1 0%→100%
9	000-255	RED 2 0%→100%
10	000-255	GREEN 2 0%→100%
11	000-255	BLUE 2 0%→100%
12	000-255	RED 3 0%→100%
13	000-255	GREEN 3 0%→100%
14	000-255	BLUE 3 0%→100%
15	000-255	RED 4 0%→100%
16	000-255	GREEN 4 0%→100%
17	000-255	BLUE 4 0%→100%
18	000-255	RED 5 0%→100%
19	000-255	GREEN 5 0%→100%
20	000-255	BLUE 5 0%→100%
21	000-255	RED 6 0%→100%
22	000-255	GREEN 6 0%→100%
23	000-255	BLUE 6 0%→100%
24	000-255	RED 7 0%→100%
25	000-255	GREEN 7 0%→100%
26	000-255	BLUE 7 0%→100%
27	000-255	RED 8 0%→100%
28	000-255	GREEN 8 0%→100%
29	000-255	BLUE 8 0%→100%

30	000-255	RED 9 0%→100%
31	000-255	GREEN 9 0%→100%
32	000-255	BLUE 9 0%→100%
33	000-255	RED 10 0%→100%
34	000-255	GREEN 10 0%→100%
35	000-255	BLUE 10 0%→100%
36	000-255	RED 11 0%→100%
37	000-255	GREEN 11 0%→100%
38	000-255	BLUE 11 0%→100%
39	000-255	RED 12 0%→100%
40	000-255	GREEN 12 0%→100%
41	000-255	BLUE 12 0%→100%
42	000-255	RED 13 0%→100%
43	000-255	GREEN 13 0%→100%
44	000-255	BLUE 13 0%→100%
45	000-255	RED 14 0%→100%
46	000-255	GREEN 14 0%→100%
47	000-255	BLUE 14 0%→100%
48	000-255	RED 15 0%→100%
49	000-255	GREEN 15 0%→100%
50	000-255	BLUE 15 0%→100%
51	000-255	RED 16 0%→100%

52	000-255	GREEN 16 0%→100%
53	000-255	BLUE 16 0%→100%
54	000-255	RED 17 0%→100%
55	000-255	GREEN 17 0%→100%
56	000-255	BLUE 17 0%→100%
57	000-255	RED 18 0%→100%
58	000-255	GREEN 18 0%→100%
59	000-255	BLUE 18 0%→100%
60	000-255	RED 19 0%→100%
61	000-255	GREEN 19 0%→100%
62	000-255	BLUE 19 0%→100%
63	000-255	RED 20 0%→100%
64	000-255	GREEN 20 0%→100%
65	000-255	BLUE 20 0%→100%
66	000-255	RED 21 0%→100%
67	000-255	GREEN 21 0%→100%
68	000-255	BLUE 21 0%→100%
69	000-255	RED 22 0%→100%
70	000-255	GREEN 22 0%→100%
71	000-255	BLUE 22 0%→100%
72	000-255	RED 23 0%→100%
73	000-255	GREEN 23 0%→100%

74	000-255	BLUE 23 0%→100%
75	000-255	RED 24 0%→100%
76	000-255	GREEN 24 0%→100%
77	000-255	BLUE 24 0%→100%
78	000-255	RED 25 0%→100%
79	000-255	GREEN 25 0%→100%
80	000-255	BLUE 25 0%→100%
81	000-255	RED 26 0%→100%
82	000-255	GREEN 26 0%→100%
83	000-255	BLUE 26 0%→100%
84	000-255	RED 27 0%→100%
85	000-255	GREEN 27 0%→100%
86	000-255	BLUE 27 0%→100%
87	000-255	RED 28 0%→100%
88	000-255	GREEN 28 0%→100%
89	000-255	BLUE 28 0%→100%
90	000-255	RED 29 0%→100%
91	000-255	GREEN 29 0%→100%
92	000-255	BLUE 29 0%→100%
93	000-255	RED 30 0%→100%
94	000-255	GREEN 30 0%→100%
95	000-255	BLUE 30 0%→100%

96	000-255	RED 31 0%→100%
97	000-255	GREEN 31 0%→100%
98	000-255	BLUE 31 0%→100%
99	000-255	RED 32 0%→100%
100	000-255	GREEN 32 0%→100%
101	000-255	BLUE 32 0%→100%
102	000-255	WHITE 1 0%→100%
103	000-255	WHITE 2 0%→100%
104	000-255	WHITE 3 0%→100%
105	000-255	WHITE 4 0%→100%
106	000-255	WHITE 5 0%→100%
107	000-255	WHITE 6 0%→100%
108	000-255	WHITE 7 0%→100%
109	000-255	WHITE 8 0%→100%
110	000-255	WHITE 9 0%→100%
111	000-255	WHITE 10 0%→100%
112	000-255	WHITE 11 0%→100%
113	000-255	WHITE 12 0%→100%
114	000-255	WHITE 13 0%→100%
115	000-255	WHITE 14 0%→100%
116	000-255	WHITE 15 0%→100%
117	000-255	WHITE 16 0%→100%

70 Channels (Mode 11):

CHANNEL	VALUE	FUNCTION
1	000-005 006-255	DIMMER Null 0%→100%
2	000-007 008-127 128-130 131-250 251-255	STROBE (RGB) Null Strobe from Slow to Fast Null Random Null
3	000-007 008-127 128-130 131-250 251-255	STROBE (W) Null Strobe from Slow to Fast Null Random Null
4	000-255	FROST 0%→100%
5	000-255	RED 1 0%→100%
6	000-255	GREEN 1 0%→100%
7	000-255	BLUE 1 0%→100%
8	000-255	RED 2 0%→100%
9	000-255	GREEN 2 0%→100%
10	000-255	BLUE 2 0%→100%
11	000-255	RED 3 0%→100%
12	000-255	GREEN 3 0%→100%
13	000-255	BLUE 3 0%→100%
14	000-255	RED 4 0%→100%
15	000-255	GREEN 4 0%→100%
16	000-255	BLUE 4 0%→100%

17	000-255	RED 5 0%→100%
18	000-255	GREEN 5 0%→100%
19	000-255	BLUE 5 0%→100%
20	000-255	RED 6 0%→100%
21	000-255	GREEN 6 0%→100%
22	000-255	BLUE 6 0%→100%
23	000-255	RED 7 0%→100%
24	000-255	GREEN 7 0%→100%
25	000-255	BLUE 7 0%→100%
26	000-255	RED 8 0%→100%
27	000-255	GREEN 8 0%→100%
28	000-255	BLUE 8 0%→100%
29	000-255	RED 9 0%→100%
30	000-255	GREEN 9 0%→100%
31	000-255	BLUE 9 0%→100%
32	000-255	RED 10 0%→100%
33	000-255	GREEN 10 0%→100%
34	000-255	BLUE 10 0%→100%
35	000-255	RED 11 0%→100%
36	000-255	GREEN 11 0%→100%
37	000-255	BLUE 11 0%→100%
38	000-255	RED 12 0%→100%

39	000-255	GREEN 12 0%→100%
40	000-255	BLUE 12 0%→100%
41	000-255	RED 13 0%→100%
42	000-255	GREEN 13 0%→100%
43	000-255	BLUE 13 0%→100%
44	000-255	RED 14 0%→100%
45	000-255	GREEN 14 0%→100%
46	000-255	BLUE 14 0%→100%
47	000-255	RED 15 0%→100%
48	000-255	GREEN 15 0%→100%
49	000-255	BLUE 15 0%→100%
50	000-255	RED 16 0%→100%
51	000-255	GREEN 16 0%→100%
52	000-255	BLUE 16 0%→100%
53	000-255	WHITE 1 0%→100%
54	000-255	WHITE 2 0%→100%
55	000-255	WHITE 3 0%→100%
56	000-255	WHITE 4 0%→100%
57	000-255	WHITE 5 0%→100%
58	000-255	WHITE 6 0%→100%
59	000-255	WHITE 7 0%→100%
60	000-255	WHITE 8 0%→100%

61	000-255	WHITE 9 0%→100%
62	000-255	WHITE 10 0%→100%
63	000-255	WHITE 11 0%→100%
64	000-255	WHITE 12 0%→100%
65	000-255	WHITE 13 0%→100%
66	000-255	WHITE 14 0%→100%
67	000-255	WHITE 15 0%→100%
68	000-255	WHITE 16 0%→100%
69	000-255	FADE (RGB) 0%→100%
70	000-255	FADE (W) 0%→100%

LED PIXEL ZONES:

39-channel (RGB)

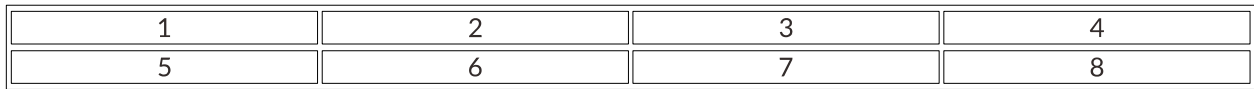

39-channel (W)

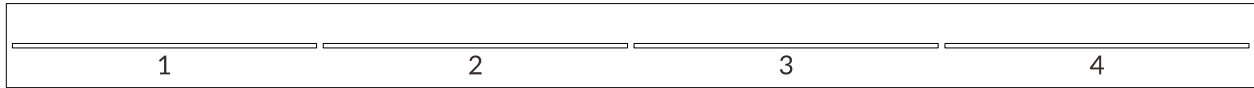

112/117-channel (RGB)

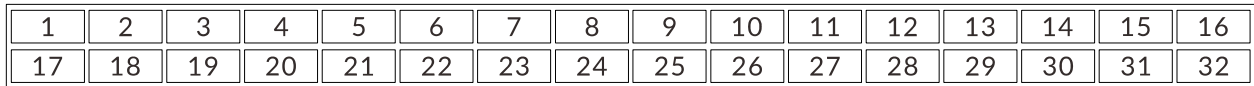

112/117-channel (W)

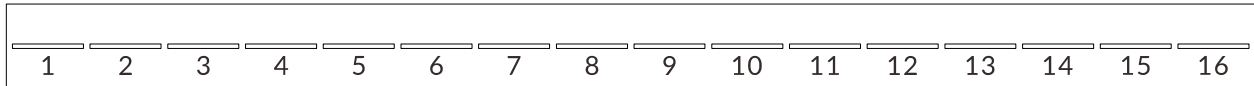

17-channel (RGB)



17-channel (W)



33-channel (RGB)



33-channel (W)

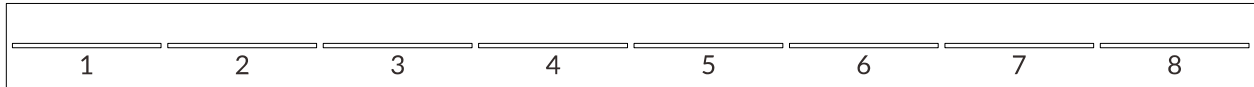

65/68/70-channel (RGB)

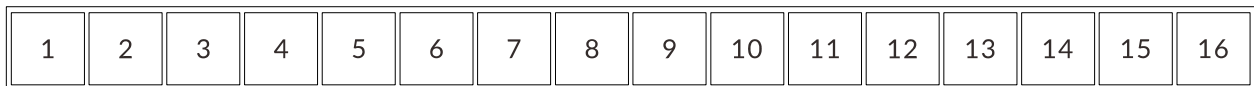

65/68/70-channel (W)

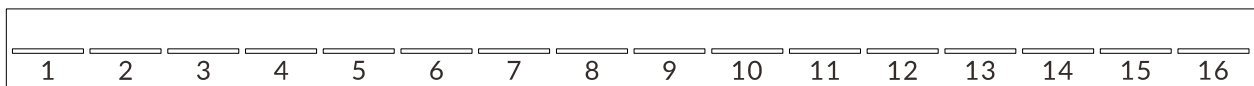

07/ Error Information

Error codes are shown continuously in the display when the fixture fails and they will not disappear until the fixture is repaired.

LED Fan Error

Check whether the fan is not running.
Check whether the fan leads are installed in place or disconnected.
Check whether the fan is damaged.
Check whether there are obstacles in the fan operating range.
Check whether the fan circuit on the motherboard breaks down.
Check whether the component is damaged.
Check whether the fan is out of order.

Led Temp. Error

Check whether the temperature detecting board is normal.
Check whether the components of the temperature detecting board are damaged.
Check whether the lead on the temperature detecting board is installed in place or disconnected.

LED Timeout Error

LED Too Hot Off

When the fixture temperature reaches 72°C, it will automatically turn off to protect the fixture.

08/ Troubleshooting

Following are a few common problems that may occur during operation. Here are some suggestions for troubleshooting:

A. The unit does not work, no light and the fan does not work

- ▶ Check the connected power.
- ▶ Measure the voltage.
- ▶ Check the power indicator to see whether it can be lit up or not.

B. Not responding to the DMX controller

- ▶ Check whether the DMX connectors and the DMX cables are connected correctly.
- ▶ Check whether the DMX address is correctly set.
- ▶ If the intermittent DMX signal problem occurs, check whether the XLR socket and the signal cable are well connected.
- ▶ Try it with another DMX controller.
- ▶ Check whether the DMX cables run near or alongside to the high-voltage cables, which may damage or interfere with the signal circuit.

09/ Fixture Cleaning

It is absolutely essential that the fixture is kept clean to ensure the maximum light-output and allow the fixture to function reliably throughout its life. The fixture must be cleaned regularly to avoid dust, dirt and smoke-fluid residues building up on or within the fixture. The cleaning frequency depends on the application environment. Clean the fixture immediately if the dust enters it to avoid damage to the optical lens due to excessive dust.

- ▶ A soft lint-free cloth moistened with any good glass cleaning fluid is recommended, under no circumstances should solvents be used.
- ▶ Always dry the parts carefully.
- ▶ Clean the external optical lens at least every 20 days.

Declaration of Conformity

We declare that our products (lighting equipments) comply with the following specification and bears CE mark in accordance with the provision of the Electromagnetic Compatibility (EMC) Directive 2014/30/EU.

EN 55032: 2015+A11: 2020; EN 55035: 2017+A11: 2020;
EN IEC 61000-3-2: 2019; EN 61000-3-3: 2013+A1: 2019.

&

Harmonized Standard

EN 60598-2-17: 2018;

EN 60598-1: 2015+A1: 2018.

Safety of household and similar electrical appliances
Part 1: General requirements and tests

Certifications

cETLus Approved (Control #5000057)