

User manual

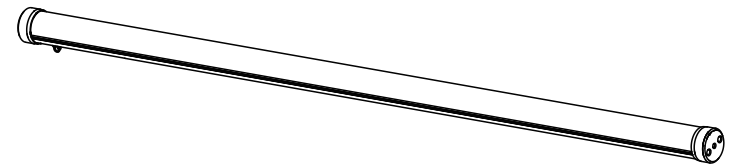

MOBI TUBE 1000



FX LIGHTING

FX-LIGHTING.COM

Please read carefully before use



Please Note: Specifications and improvements in the design of this unit and this manual are subject to change without any prior written notice.

Packaging: Thanks for your purchasing Mobi tube 1000. All the lights have been checked and are in excellent operating condition. Please check the shipping carton first, because there may be damage occurred during the shipment. Then check the lights carefully and be sure that the lights is intact and works normally. In the event damage has been found, spare parts are missing or the lights works abnormally, please contact us for further instructions. And please don't return the lights to the dealer before contacting us.

Introduction: Mobi tube 1000 is a mini wall washer with excellent performance. It is 200mm long, but its width of covering wall is 5m. 2.4G remote control is included. The house is made of extruded aluminum and die-cast aluminum cover. The ingress protection rating is IP65. However, there is no glue was used into the light. Mobi tube 1000 has won many certifications, including the CE, ROHS and so on.

SAFETY AND HANDLING

Before you operate this unit read the manual carefully. Always make sure to include the manual if you pass/rent/sell the unit to another user. Keep in mind that this manual cannot address all possible dangers and environments. Please use your own caution when operating. This product is for professional use only. It is not for household use.



- Do not operate the unit in areas of high temperature conditions. It will cause abnormal function or damage the product.
- Always use a suitable safety wire when mounting the light overhead.
- Connect the safety wire only to the intended safety mount.
- Always follow local safety requirements.



- Only qualified personnel may repair this product.
- Do not open the product housing.
- Do not apply power if the light is damaged.



- Do not directly look into the light.
- It can cause harm to your eyes.
- Do not look at the LEDs with a magnifying glass or any other optical instrument that may concentrate the light output.



- The exterior surfaces of the light can become hot, up to 70°C during normal operation.
- Ensure that accidental physical contact with the device is impossible.
- Install only in ventilated locations.
- Do not cover the light.



LI-ION Battery: A rechargeable lithium ion battery is built into this unit.

- Only authorized personal may service the battery.
- Do not place in fire or heat.
- Do not use or charge the light if it is damaged.
- Avoid bumping or plunging, it may cause fire or explosion.
- Never store the battery when fully drained.
- Always recharge immediately when empty.
- Make sure to fully charge all units before storing them.
- Partially charged batteries will lose capacity.
- The battery may only be replaced with an original spare part.



- Always charge with the flight case open.
- It is recommended to charge at a temperature between 15°C and 35°C



- The light contains a lithium ion battery.
- Don't throw the unit into the garbage at the end of its lifetime.
- Make sure to dispose is according to your local ordinances and/or regulations, to avoid polluting the environment!
- The packaging is recyclable and can be disposed.

Troubleshooting

The fixture does not turn on.

The battery may be empty. Connect it to the power cable and try again.

The fixture turns on and the display is on, but the LEDs do not emit light.

The fixture could be set to BLACKOUT mode, set to is DMX Hold and doesn't receive a valid signal. It is good practice to do a Factory Reset.

The fixture is not working correctly - it does not display the color or effect chosen.

The fixture may still be operating under a previous setting. It is good practice to do a Factory Reset.

After completing a RESET SETTINGS, the fixture still cannot be controlled.

Please turn off the light and turn on again, if cannot be controlled, too, please consult authorized personal.

The fixture does not run long enough on battery.

The required RUNTIME can be set. It defaults to several hours. To achieve a greater battery runtime, set the RUNTIME to the required value.

Alternatively, program the fixture to only display colors that use less power, such as Red, Green, Blue and White.

If the runtime is still too short, consider that it is reduced slightly if the battery is very cold.

The power cable is connected but the fixture is not charging.

The battery may be fully charged. Please read our user manual for more details. The fixture will only commence charging when its battery has a temperature of 45° or less. Turn the fixture off and let it cool down; once cold enough, it will start charging. If it still not charging, please consult authorized personal.

4. During the flashing of the remote control light, the lamp flashes 3 times, which means that the connection is successful.







5. After the match is successful, when the remote control light is on, it means that the group of lamps is being controlled.





6. If there are multiple lamps that need to be connected, please repeat the above steps and press the  button to select different groups for connection. (Each group can connect up to 50 lamps.)

7. The furthest remote control distance of this product is about 50 meters. No need to rematch after power failure.

2.4G Remote



-  **Power on/off button**
Press and hold the power button for 3 seconds to turn on/off the remote control, short press the control light switch
-  **DMX button**,to control DMX address when press this button.It is SLAVE mode when double click.
-  **AUTO** The first one is Auto Mode.It is Speed mode when double click.
-  **SOUND** The first one is Sound Mode.It is Speed mode when double click.
-  **Strobe mode button**
-  **Up and down button**,you can choose the program that you need or numerical.
-  **Switching group button**
Press and hold the button for 5 seconds to enter matching mode

    Group indicator light  Press color button enter color menu

      Color choosing button.

         

You can use these number button to adjust numerical in any program mode.

How to connect 2.4G remote control

1. Press and hold the  button for 3 seconds to turn on or off the power of the remote control (the indicator light indicates that the remote control is turned on, and the remote control power will be automatically turned off after 1 minute of no operation).

!!The indicator light will automatically turn off after 1 minute of use and need to be pressed again for 3 seconds to turn on again.

2.Press and hold the  button for 5 seconds, the indicator blinks, enters the matching mode, and automatically exits the pair mode after 20 seconds.

3.Turn on the light and enter [SETUP]→[REMOTE]→[ON], press the [ENTER] key to enter the matching mode. (If [ON] is displayed in the [REMOTE] mode during startup, you need to press the [ENTER] key again to enter the matching mode.)

Features

- LED Engine:80pcs*1W RGB+Mint+Amber colors
- Total LED Power 70 W
- Luminous Flux 3200K 2 600 Lumens
- Luminous Flux 4000K 2 800 Lumens
- Light Output 3200 K @ 1m 800 Lux
- Light Output 4000 K @ 1m 850 Lux
- CRI (Ra)/ TLCI 3200- 6500 K* ≥95
- Beam Angle 135° x 115°
- Field Angle 175° x 160°
- Strobe 0 - 25 Hz
- Pixels 16
- Battery Runtime up to 24 hours
- Battery Runtime Max Brightness 2.5 hours
- Battery Lifetime 70 % after 300 cycles
- Charging Time (nominal) 3 hours
- DC Input 24 VDC - 2 A
- DC Connector 5.5 mm x 2.1 mm
- Wired DMX Yes (via 4 pin M8 connector)
- CRMX Receiver Built-in
- 2.4G remote control (within 50m)
- Wireless Range CRMX up to 300 m
- Housing Material Polycarbonate, Aluminium and ABS materials
- IP Rating IP65
- Ambient Operating Temperature 0 - 40 °C / 32 - 104 °F
- Weight 1.35 kg
- Dimensions 1035 mm x 43 mm x 43 mm
- Mounting Options 2x M8 thread, 2x TubeHolder (with 2x M5 and 1x 1/4" - 20 UNC thread), 1x TubeStand

Mechanical Specification

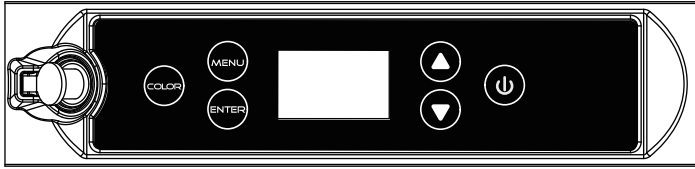

	When at top navigation When open navigation	When inside Main Menu
	ON/OFF	
	Enter Main Menu	Back to previous Menu
	Click enter button to enter the page	Select the option you want from the menu and click enter to confirm
	Click the up button to select	Select the option you want from the menu and click the Up button to move up
	Click the down button to select	Select the option you want from the menu and click the Down button to move down
	Click the color button to enter and select the color	

Product Overview

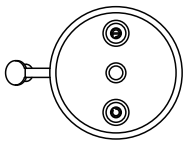
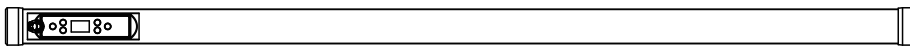
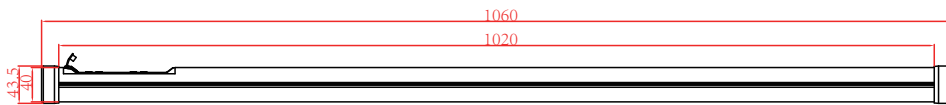

Tips & tricks

There are limitations to how wireless waves propagate through air. Physical barriers like glass, concrete and walls will limit the transmission range. Always try to have clear line-of-sight between transmitters and receivers.

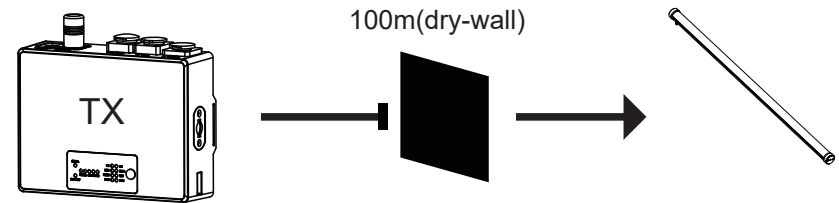
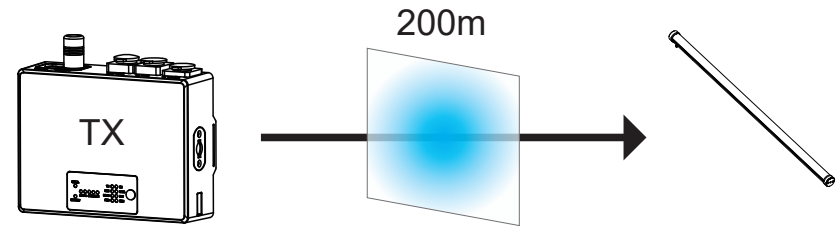

Wireless indicator status	Description
Both blinking red color	wireless transmitter or receiver OFF or not linked with the projector
Both blinking but: Wireless green	Master and Slave with the projector not connect success
Both fixed green color	Master-Transmitter mode ON and linked with the projector Slave- Receiver

Connection in wireless mode -DMX



When connection wireless mode, please remember release first.

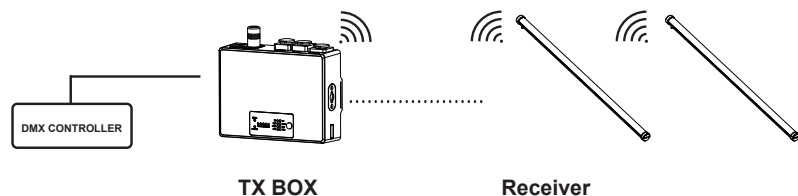

DMX led status and wireless indicator	Description
Both blinking red color	DMX not connected e wireless transmitter OFF or not linked with the projector
Both blinking but: DMX red - Wireless green	DMX not connected,transmitter ON and linked with the projector
Both fixed green color	Dmx connected,transmitter ON and linked with the projector

Programme Menu

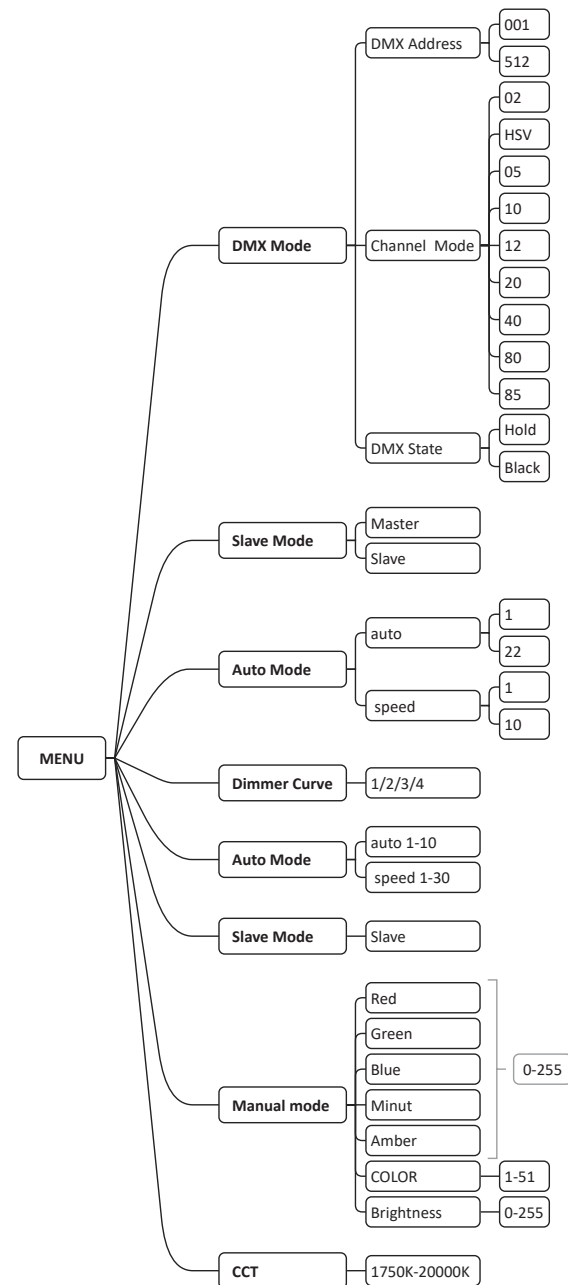

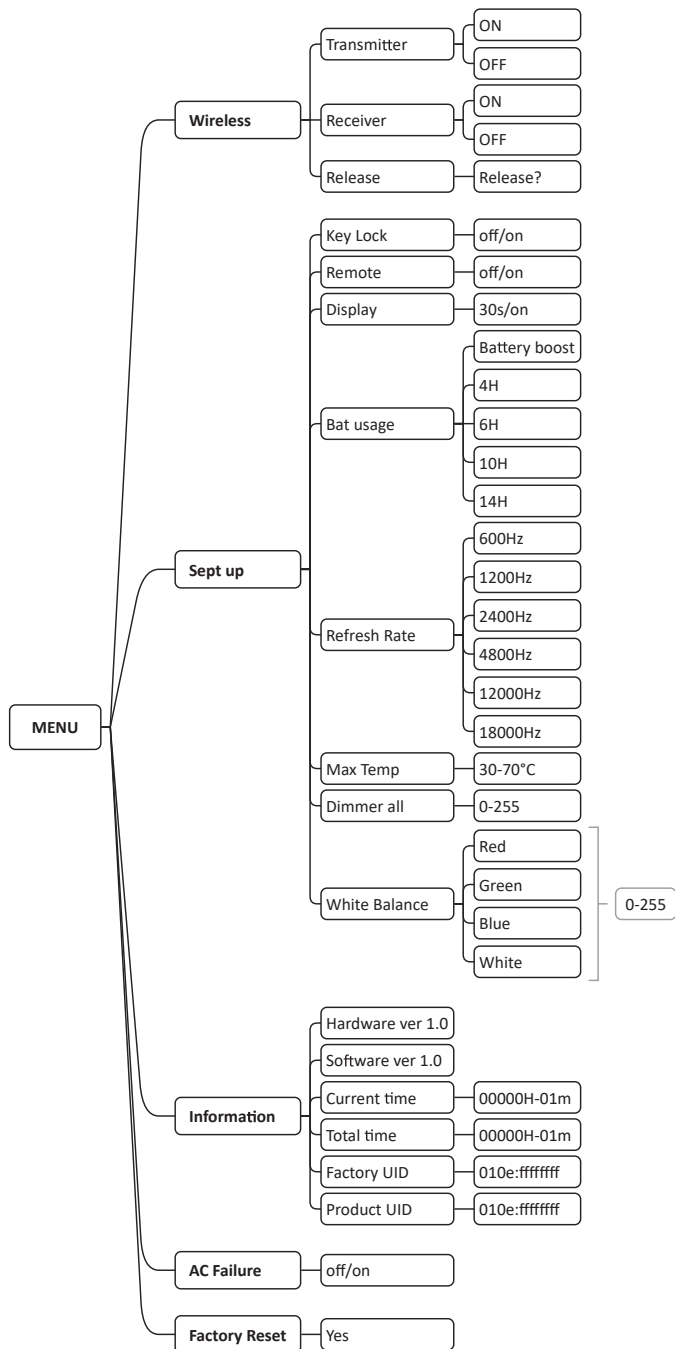

CHARGE WITH ABS CASE



DURING THE COMPLETE PROCESS OF BATTERIES CHARGE THE UPPER COVER OF THE FLIGHTCASE MUST BE ALWAYS OPEN.



DURING THE COMPLETE PROCESS OF BATTERIES CHARGE THE PROJECTORS MUST BE ALWAYS OFF.

For correct use of the battery it is strongly recommended to:

- Charge the battery at least one time each month
- The minimum level of the charge must be not less than 5%

During the charge, the battery icon (visible on the display) will show the level of the charge. When the charge is finished, the icon will be totally green.

Connection in wireless mode - Master/Slave



When connection wireless mode, please remember release first.



**Master
-Transmitter mode**

**Slave
-Receiver**

Hanging, Stand

The Helios Tube can be hung via a bolt or clamp. When hanging, secure with safety wire and carabiner that hold at least 15kg. Make sure the light cannot drop more than 20cm if primary mounting fails.

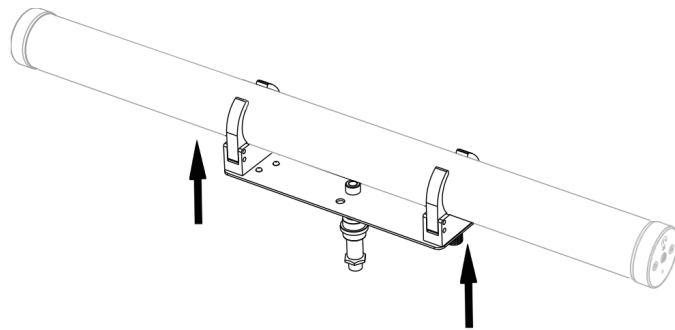
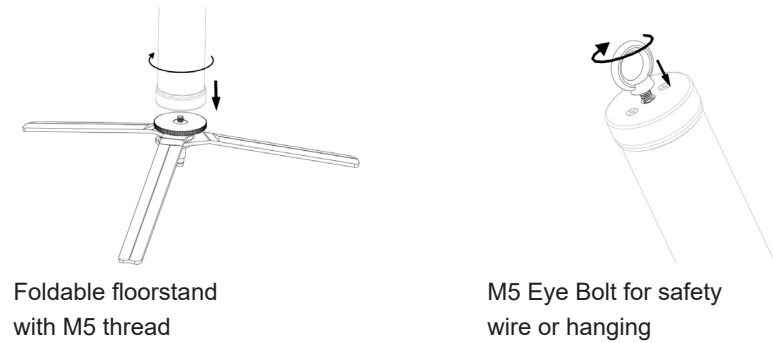
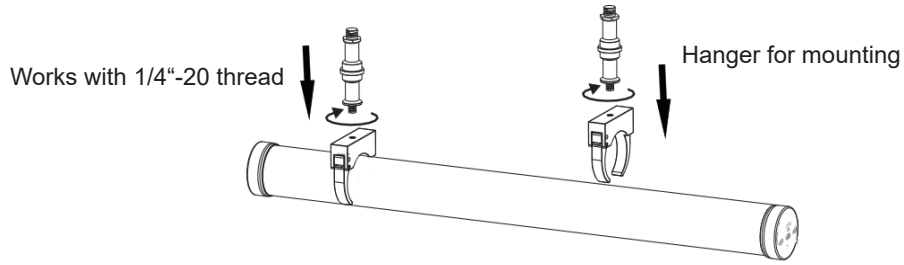

Works with 1/4"-20 thread/

Displayer Introduction

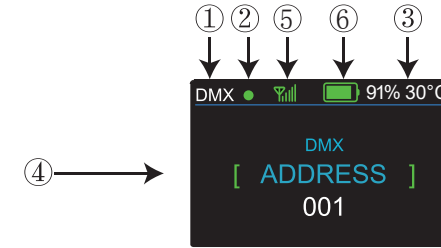

1. When you enter DMX Mode, it will be shown DMX, when you enter SLAVE Mode, it will be shown SLAVE.
2. This shows the condition of signal transmission. Green is connected. Red is disconnected.
3. This shows the temperature of the lights.
4. This shows the menus you can select.
5. This shows the condition of wireless signal. Green is connected. Red is disconnected.
6. This shows the battery's electric quantity.

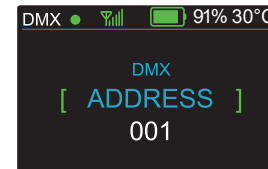

While DMX and Wireless signal are green, it means DMX Mode and Wireless are connected.

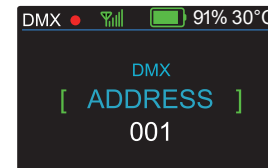

While DMX shows red but Wireless signal shows green, it means DMX Mode is disconnected and Wireless is connected.

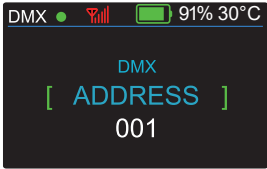

While DMX shows green but Wireless signal shows red, it means DMX Mode is connected and Wireless is disconnected.

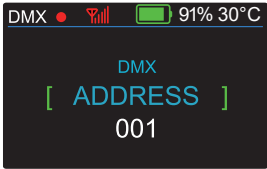

While DMX and Wireless are show red, it means DMX Mode and Wireless are disconnected.

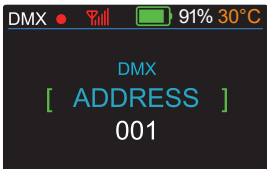

While the letters and number shows change from white to yellow, it means the temperature beyond max temperature of default settings.

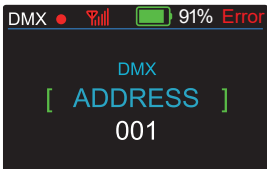

While the letters and number shows Error, it means have some problems of temperature.

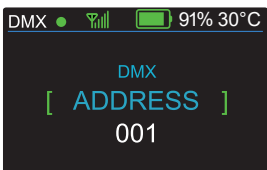

While the battery is charging, it will show running from empty to full. While you stop charging, it will show how much the electric quantity.

41	000 - 255	LED group 8 Minut
42	000 - 255	LED group 8 Amber
43	000 - 255	LED group 9 Red
44	000 - 255	LED group 9 Green
45	000 - 255	LED group 9 Blue
46	000 - 255	LED group 9 Minut
47	000 - 255	LED group 9 Amber
48	000 - 255	LED group 10 Red
49	000 - 255	LED group 10 Green
50	000 - 255	LED group 10 Blue
51	000 - 255	LED group 10 Minut
52	000 - 255	LED group 10 Amber
53	000 - 255	LED group 11 Red
54	000 - 255	LED group 11 Green
55	000 - 255	LED group 11 Blue
56	000 - 255	LED group 11 Minut
57	000 - 255	LED group 11 Amber
58	000 - 255	LED group 12 Red
59	000 - 255	LED group 12 Green
60	000 - 255	LED group 12 Blue
61	000 - 255	LED group 12 Minut
62	000 - 255	LED group 12 Amber
63	000 - 255	LED group 13 Red
64	000 - 255	LED group 13 Green
65	000 - 255	LED group 13 Blue
66	000 - 255	LED group 13 Minut
67	000 - 255	LED group 13 Amber
68	000 - 255	LED group 14 Red
69	000 - 255	LED group 14 Green
70	000 - 255	LED group 14 Blue
71	000 - 255	LED group 14 Minut
72	000 - 255	LED group 14 Amber
73	000 - 255	LED group 15 Red
74	000 - 255	LED group 15 Green
75	000 - 255	LED group 15 Blue
76	000 - 255	LED group 15 Minut
77	000 - 255	LED group 15 Amber
78	000 - 255	LED group 16 Red
79	000 - 255	LED group 16 Green
80	000 - 255	LED group 16 Blue
81	000 - 255	LED group 16 Minut
82	000 - 255	LED group 16 Amber
83	000 - 255	Strobe
84	000 - 255	Auto
85	000 - 255	Auto speed

85 channels		
Channel	Value	Function
1	000 - 255	Master dimmer
2	000 - 255	Dimmer curve
3	000 - 255	LED group 1 Red
4	000 - 255	LED group 1 Green
5	000 - 255	LED group 1 Blue
6	000 - 255	LED group 1 Minut
7	000 - 255	LED group 1 Amber
8	000 - 255	LED group 2 Red
9	000 - 255	LED group 2 Green
10	000 - 255	LED group 2 Blue
11	000 - 255	LED group 2 Minut
12	000 - 255	LED group 2 Amber
13	000 - 255	LED group 3 Red
14	000 - 255	LED group 3 Green
15	000 - 255	LED group 3 Blue
16	000 - 255	LED group 3 Minut
17	000 - 255	LED group 3 Amber
18	000 - 255	LED group 4 Red
19	000 - 255	LED group 4 Green
20	000 - 255	LED group 4 Blue
21	000 - 255	LED group 4 Minut
22	000 - 255	LED group 4 Amber
23	000 - 255	LED group 5 Red
24	000 - 255	LED group 5 Green
25	000 - 255	LED group 5 Blue
26	000 - 255	LED group 5 Minut
27	000 - 255	LED group 5 Amber
28	000 - 255	LED group 6 Red
29	000 - 255	LED group 6 Green
30	000 - 255	LED group 6 Blue
31	000 - 255	LED group 6 Minut
32	000 - 255	LED group 6 Amber
33	000 - 255	LED group 7 Red
34	000 - 255	LED group 7 Green
35	000 - 255	LED group 7 Blue
36	000 - 255	LED group7 Minut
37	000 - 255	LED group 7 Amber
38	000 - 255	LED group 8 Red
39	000 - 255	LED group 8 Green
40	000 - 255	LED group 8 Blue

DMX MODE-In this menu,you can connect several pieces of lights with DMX wireless box.

- 1.Press "ENTER"button and then UP or DOWN button until "DMX Mode" is showed.
- 2.Press "ENTER"button,and "Channels Mode" "DMX Address"or "DMX State"will be showed.Then press ENTER.

- 1)"Channel [xx]"will be showed,"X"represents the showed DMX channel mode.You can press the UP or DOWN button to select your desired Channel mode(2,HSV,5,10,12,20,40,80,85).
- 2)"xxx"will be showed,"x"represents the showed address.You can press the UP or DOWN button to select your desired address from 001 to 512.
- 3)"Hold" or "Black"will be showed,you can press the UP or DOWN button to select your desired DMX State.

Dim Curve-In this menu,you can adjust the brightness of the light .

- 1.Press "ENTER"button and then UP or DOWN button until "Dim Curve" is showed.
- 2.Press "ENTER"button,and "CURVE1" to"CURVE4"will be showed.Then press ENTER to select your desired Dim Curve.

Auto Mode-In this menu,you can select your desire Auto Mode and adjust the running speed.

- 1.Press"ENTER"button and then UP or DOWN button until"Auto Mode"is showed.
- 2.Press"ENTER"button,and"SPEED"or"AUTO MODE"will be showed.Then press ENTER,and you can see two items as below:

- 1)SPEED-You can select your desired speed from 01 to 10 in this menu.
- 2)AUTO MODE-You can select your desired auto mode from 01 to 30 in this menu.

Slave Mode-In this menu,you can select one light as the MASTER light and other lights in SLAVE mode will run following the MASTER light.

- 1.Press "ENTER"button and then UP or DOWN button until "Slave Mode"is showed.
- 2.Press "ENTER"button again to enter Slave Mode.

Manual Mode-In this menu, you can edit a scene by adjusting the value of"Red(0~255)", "Green(0~255)", "Blue(0~255)",Mint(0~255),Amber(0~255)", "Strobe(0~20)", "Brightness(0~255)"and"Color(1~101)"as you like.Then the data will be saved,when you press the ENTER button for 5 seconds.

- 1.Press "ENTER"button and then UP or DOWN button until "Manual Mode"is showed.
- 2.Press"ENTER"button,and there will be six options.Then press ENTER,and you can see eight items as below:

- 1)Red-You can adjust the red brightness in this menu.
- 2)Green-You can adjust the green brightness in this menu.
- 3)Blue-You can adjust the blue brightness in this menu.
- 4)Mint-You can adjust the Mint brightness in this menu.
- 5)Amber-You can adjust the Amber brightness in this menu.
- 6)Brightness-You can adjust the brightness in this menu.
- 7)Strobe-You can adjust the strobe mode in this menu.
- 8)Color -You can select 51 different kinds of color in this menu.

CTO-In this menu,you can adjust the color temperature.

- 1.Press"ENTER"button and then UP or DOWN button until"CTO"is showed.
- 2.Press"ENTER"button,and ,you can adjust the color temperature from 1750k to 20000k.

Wireless-In this menu,you can transmit, receive or clear wireless signals.

- 1.Press"ENTER"button and then UP or DOWN button until"Wireless"is showed.
- 2.Press"ENTER"button,and"Transmitter", "Receiver"or "Release"will be showed.Then press ENTER,and you can see three items as below:

1)Transmitter- In this item,you can select "ON"or "OFF".If you select ON,you can use the wireless transmission function.And if you select OFF,wireless transmission will be turned off.

2)Receiver- In this item,you can select "ON"or "OFF".If you select ON,you can use the wireless reception function.And if you select OFF,wireless reception will be turned off.

3)Release-In this item, you can clear wireless signals."SUCCEESS" will be displayed when the wireless signal is successfully cleared.

Set Up-In this menu,you can adjust the value of the function.

1.Press "ENTER"button and then UP or DOWN button until "Set Up"is showed.

2.Press "ENTER"button,and there will be eight options.Then,press ENTER to select the option and press UP or DOWN button to select the value you desire as below.

1)Key Lock-You can select whether the password is on or off in this menu and the password is DOWN +UP]DOWN]UP].If you select"on",then you have to input the password before pressing the buttons.Otherwise,the light won't respond to your order.

2)Remote-If you select"on",you can connect 2.4G remote control.On the contrary, the remote control function will be disabled.

3)Display-In this item,you can select "30s"or "ON".If you select ON,the display will be on all the time.And if you select 30s,the screen will turn off after 30 seconds.

4)Bat Usage-You can select the battery usage mode.Battery boost is the most power-hungry mode and 14H is the most power-saving mode and in addition to that, there are 4,6,10,12 hours to choose from.

5)Refresh Rate-You can select the refresh rate from 600Hz to 18k Hz.

6)Max temp- You can set the your desired Max working temperature about the light from 30°to 70° in this menu.When the working temperature of the light exceeds the Max temperature,the color of letter"Temp xx"showed in the menu will change from white to yellow.Meanwhile,the light will adjust the working temperature automatically.

7)Dimmer All-You can adjust the brightness of each color from 0 to 255 in this menu.

8)Balance-You can adjust the value of"Red","Green"and"Blue" from 0 to 255.

Info-In this menu,you can learn about the information of software,hardware,the total time and current time of the light and the RDM UID number of the light.

1.Press "ENTER"button and then UP or DOWN button until "Info"is showed.

2.Press"ENTER"button,and"Software ver""Hardware ver","Current Time","Total Time" and "RDM UID"will be showed.Then press ENTER,and you can see five items as below:

1)Software ver-This item displays the Software information.

2)Hardware ver-This item displays the Hardware information.

3)Mode-This item display lamp model information.

3)Current times-This item displays the current working hours of the light.

4)Total times-This item displays the total working hours of the light.

5)RDM UID-This item displays the RDM UID number of the light.

AC Failure-In this menu,you can test the power supply system for proper operation.

1.Press "ENTER"button and then UP or DOWN button until "AC Failure"is showed.

2.Press"ENTER"button,and"ON" or "OFF"will be showed. If you select"on",emergency light function can be activated after power failure.

Factory Reset-In this menu,you can reset all the value of the system.

1.Press"ENTER"button and then UP or DOWN button until"Factory Reset"is showed.

2.Press the ENTER button to reset all the value of the system,and the password is DOWN +UP]DOWN]UP].

39	000 - 255	LED group 8 Minut
40	000 - 255	LED group 8 Amber
41	000 - 255	LED group 9 Red
42	000 - 255	LED group 9 Green
43	000 - 255	LED group 9 Blue
44	000 - 255	LED group 9 Minut
45	000 - 255	LED group 9 Amber
46	000 - 255	LED group 10 Red
47	000 - 255	LED group 10 Green
48	000 - 255	LED group 10 Blue
49	000 - 255	LED group 10 Minut
50	000 - 255	LED group 10 Amber
51	000 - 255	LED group 11 Red
52	000 - 255	LED group 11 Green
53	000 - 255	LED group 11 Blue
54	000 - 255	LED group 11 Minut
55	000 - 255	LED group 11 Amber
56	000 - 255	LED group 12 Red
57	000 - 255	LED group 12 Green
58	000 - 255	LED group 12 Blue
59	000 - 255	LED group 12 Minut
60	000 - 255	LED group 12 Amber
61	000 - 255	LED group 13 Red
62	000 - 255	LED group 13 Green
63	000 - 255	LED group 13 Blue
64	000 - 255	LED group 13 Minut
65	000 - 255	LED group 13 Amber
66	000 - 255	LED group 14 Red
67	000 - 255	LED group 14 Green
68	000 - 255	LED group 14 Blue
69	000 - 255	LED group 14 Minut
70	000 - 255	LED group 14 Amber
71	000 - 255	LED group 15 Red
72	000 - 255	LED group 15 Green
73	000 - 255	LED group 15 Blue
74	000 - 255	LED group 15 Minut
75	000 - 255	LED group 15 Amber
76	000 - 255	LED group 16 Red
77	000 - 255	LED group 16 Green
78	000 - 255	LED group 16 Blue
79	000 - 255	LED group 16 Minut
80	000 - 255	LED group 16 Amber

80 channels		
Channel	Value	Function
1	000 - 255	LED group 1 Red
2	000 - 255	LED group 1 Green
3	000 - 255	LED group 1 Blue
4	000 - 255	LED group 1 Minut
5	000 - 255	LED group 1 Amber
6	000 - 255	LED group 2 Red
7	000 - 255	LED group 2 Green
8	000 - 255	LED group 2 Blue
9	000 - 255	LED group 2 Minut
10	000 - 255	LED group 2 Amber
11	000 - 255	LED group 3 Red
12	000 - 255	LED group 3 Green
13	000 - 255	LED group 3 Blue
14	000 - 255	LED group 3 Minut
15	000 - 255	LED group 3 Amber
16	000 - 255	LED group 4 Red
17	000 - 255	LED group 4 Green
18	000 - 255	LED group 4 Blue
19	000 - 255	LED group 4 Minut
20	000 - 255	LED group 4 Amber
21	000 - 255	LED group 5 Red
22	000 - 255	LED group 5 Green
23	000 - 255	LED group 5 Blue
24	000 - 255	LED group 5 Minut
25	000 - 255	LED group 5 Amber
26	000 - 255	LED group 6 Red
27	000 - 255	LED group 6 Green
28	000 - 255	LED group 6 Blue
29	000 - 255	LED group 6 Minut
30	000 - 255	LED group 6 Amber
31	000 - 255	LED group 7 Red
32	000 - 255	LED group 7 Green
33	000 - 255	LED group 7 Blue
34	000 - 255	LED group7 Minut
35	000 - 255	LED group 7 Amber
36	000 - 255	LED group 8 Red
37	000 - 255	LED group 8 Green
38	000 - 255	LED group 8 Blue

DMX control mode

2 CHANNELS		
Channel	Value	Function
1	0-255	Color 1-color 51
2	0-255	CCT(1750K-20000K)

3 CHANNELS		
Channel	Value	Function
1	0-255	Hue
2	0-255	Saturation
3	0-255	Value (brightness)

5 CHANNELS		
Channel	Value	Function
1	000 - 255	Red
2	000 - 255	Green
3	000 - 255	Blue
4	000 - 255	Minut
5	000 - 255	Amber

10 channels		
Channel	Value	Function
1	000 - 255	LED group 1 Red
2	000 - 255	LED group 1 Green
3	000 - 255	LED group 1 Blue
4	000 - 255	LED group 1 Minut
5	000 - 255	LED group 1 Amber
6	000 - 255	LED group 2 Red
7	000 - 255	LED group 2 Green
8	000 - 255	LED group 2 Blue
9	000 - 255	LED group 2 Minut
10	000 - 255	LED group 2 Amber

12 CHANNELS		
Channel	Value	Function
1	000 - 255	Master dimmer
2	000 - 255	Dimmer curve
3	000 - 255	Red
4	000 - 255	Green
5	000 - 255	Blue
6	000 - 255	Minut
7	000 - 255	Amber
8	000 - 255	Strobe (slow -fast) 25%/s
9	000 - 255	Color 1-color 51
10	000 - 255	White (1750K-20000K)
11	000 - 255	Auto effect
12	000 - 255	Auto speed

20 CHANNELS		
Channel	Value	Function
1	000 - 255	LED group 1 Red
2	000 - 255	LED group 1 Green
3	000 - 255	LED group 1 Blue
4	000 - 255	LED group 1 Minut
5	000 - 255	LED group 1 Amber
6	000 - 255	LED group 2 Red
7	000 - 255	LED group 2 Green
8	000 - 255	LED group 2 Blue
9	000 - 255	LED group 2 Minut
10	000 - 255	LED group 2 Amber
11	000 - 255	LED group 3 Red
12	000 - 255	LED group 3 Green
13	000 - 255	LED group 3 Blue
14	000 - 255	LED group 3 Minut
15	000 - 255	LED group 3 Amber
16	000 - 255	LED group 4 Red
17	000 - 255	LED group 4 Green
18	000 - 255	LED group 4 Blue
19	000 - 255	LED group 4 Minut
20	000 - 255	LED group 4 Amber

40 channels		
Channel	Value	Function
1	000 - 255	LED group 1 Red
2	000 - 255	LED group 1 Green
3	000 - 255	LED group 1 Blue
4	000 - 255	LED group 1 Minut
5	000 - 255	LED group 1 Amber
6	000 - 255	LED group 2 Red
7	000 - 255	LED group 2 Green
8	000 - 255	LED group 2 Blue
9	000 - 255	LED group 2 Minut
10	000 - 255	LED group 2 Amber
11	000 - 255	LED group 3 Red
12	000 - 255	LED group 3 Green
13	000 - 255	LED group 3 Blue
14	000 - 255	LED group 3 Minut
15	000 - 255	LED group 3 Amber
16	000 - 255	LED group 4 Red
17	000 - 255	LED group 4 Green
18	000 - 255	LED group 4 Blue
19	000 - 255	LED group 4 Minut
20	000 - 255	LED group 4 Amber
21	000 - 255	LED group 5 Red
22	000 - 255	LED group 5 Green
23	000 - 255	LED group 5 Blue
24	000 - 255	LED group 5 Minut
25	000 - 255	LED group 5 Amber
26	000 - 255	LED group 6 Red
27	000 - 255	LED group 6 Green
28	000 - 255	LED group 6 Blue
29	000 - 255	LED group 6 Minut
30	000 - 255	LED group 6 Amber
31	000 - 255	LED group 7 Red
32	000 - 255	LED group 7 Green
33	000 - 255	LED group 7 Blue
34	000 - 255	LED group 7 Minut
35	000 - 255	LED group 7 Amber
36	000 - 255	LED group 8 Red
37	000 - 255	LED group 8 Green
38	000 - 255	LED group 8 Blue
39	000 - 255	LED group 8 Minut
40	000 - 255	LED group 8 Amber